

The *Choices* brand

Windows, Doors, Conservatories

The *Choices* brand

Windows, Doors, Conservatories...

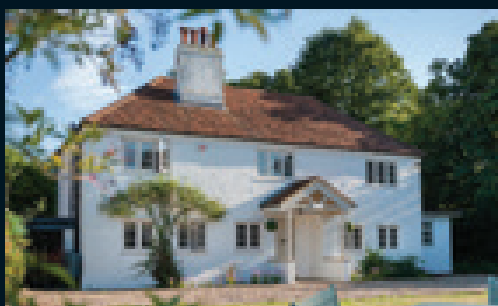

...let your imagination run wild

## Modern • Traditional • Innovative

The *Choices* brand - the brand that allows you to let your imagination run wild

You may be looking for a 'MODERN' or 'TRADITIONAL' look for your house - it's all here.

Your choice may be for **STANDARD** white or foiled PVCU windows and matching doors. However, there are other choices with our 'ALTERNATIVE TO TIMBER' collection, or if you desire traditional wooden windows and doors, view our **TIMBER** range.

For the modern look there is a full range of **ALUMINIUM** windows and doors with their neat and tidy slim frames giving more glass area.

For doors there are the usual single and double doors with a variety of designs – but also have a look at the sliding and folding doors which can bring a new dimension to your home.

Last, but by no means least, there is the **GLASS!** Choice of patterns, colours and performance. In addition, you can consider glass that helps reduce noise, increases security, improves thermal performance and even reduces fade in carpets and furniture - it's all here.

The products are all shown in the following pages and although the choice is stunning, there is one constant and that is the high quality and high performance of every product.



PVCU Windows, Doors and Conservatories



'Alternative to Timber'



Timber Range



Aluminium Windows and Doors

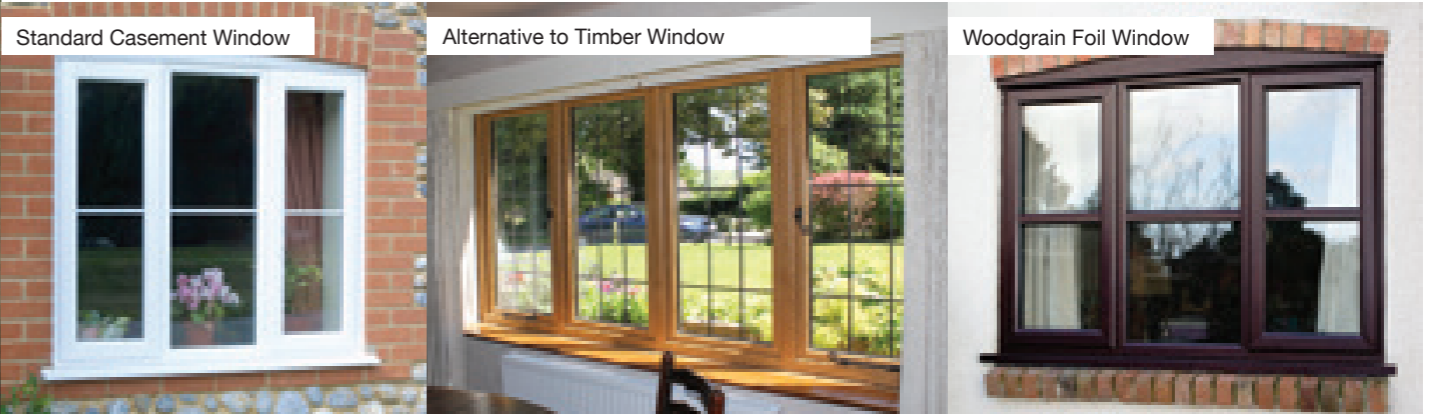

# PVCU WINDOWS

## Windows with the widest choice

*Choices* standard PVCU range offers different styles and types of windows to suit you and your property.

Your windows can be made sculptured, bevelled or flush in systems that are totally compatible with *Choices* doors and conservatories.



*Choices* thermally efficient, low maintenance windows and doors are available in a wide range of colour finishes, for example





# 'Alternative to Timber' Collection

## Flush 100

'Choices' Flush 100 'is specifically designed to replicate 19th century timber windows and doors with a flush external casement finish. Choose between two internal finishes, R9 with a decorative internal finish and R2 offering a square clean design.

Both are ideal when replacing 100mm traditional timber windows. With a choice of styling options they are ideal for period and modern properties and approved for use in conservation areas.



R9 has a traditional, decorative, internal finish



R2 with clean, square lines internally, ideal for modern interiors



Flush external finishes and external transom bar upgrade



20mm Astragal and 60mm Transom bar upgrade



## Flush 70

Flush 70 combines modern performance with traditional styling offering authenticity without compromise.

The traditional appearance coupled with the 70mm frame depth and flush casement design, combine to offer a cost effective alternative to timber.

Designed to look just like traditional timber windows makes them suitable for conservation areas.

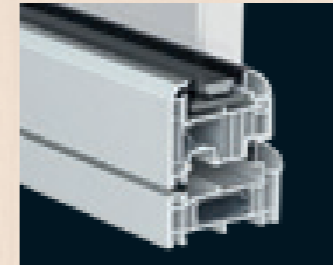

6 chambered sash for high thermal efficiency



Flush fitting sashes



## Legacy

70mm LEGACY Storm Casement windows offer the best of both worlds – they look and feel just like timber but have all the benefits of modern technology.

Legacy are an ideal cost effective solution when windows need replacing.



External putty line chamber finish with 154mm slim sash



Arched joints mimic traditional timber joinery



## Flush 75

'Choices' 'Flush 75' offers the same great external finish as 'Flush 100', but has been designed with a flush finish internally and are ideal when replacing 70mm modern systems.



Flush external finishes with equal sightlines



Flush internal finishes with decorative detailing



External transom bar upgrade

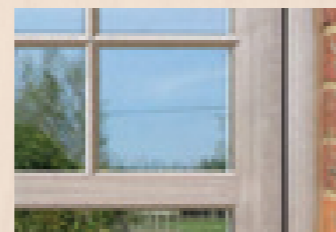

20mm Astragal and 60mm Transom bar upgrade

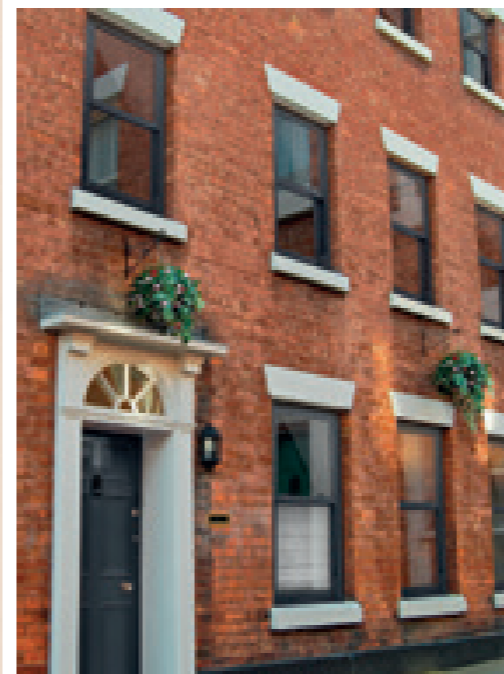

## Vertical SLIDING SASH WINDOWS

*Choices* Imagine vertical sliding sash windows offer exceptional performance, utilising modern technology whilst maintaining authentic looks.

They are easy to slide open and with both panes tilting inwards, makes cleaning the outer sides easy.

### Timber Replica Upgrades

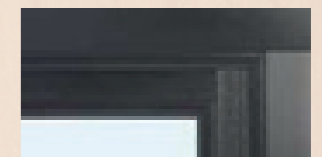

Mechanically Jointed

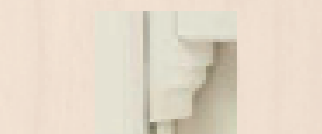

Flush RunThru Sash

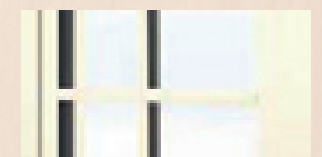

Astragal Bars



# The *Choices* brand Aluminium Windows

Slim, Neat, Tidy  
and available in  
a choice of  
different designs



Contemporary Flat Sash

Heritage Sash

Flush Sash

## Windows with the widest choice of colour and style

Manufactured from state-of-the-art Aluminium, *Choices* Aluminium windows are designed to the highest standard, making them low maintenance and with a high level of security as standard.

Available in a vast choice of colours and styles to fit any requirement.

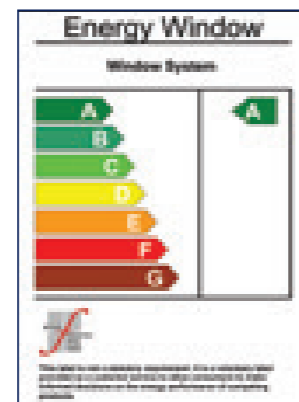

Window Energy Rating 'A' Available

## Endless choice of colour

### Standard colour range



### Customise with RAL colour

Upgrade to any single or dual RAL colour. Extended lead times apply.

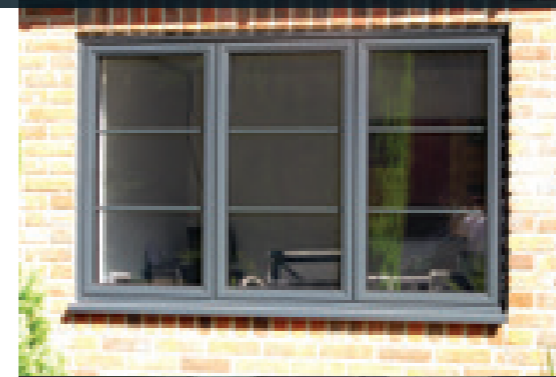

Ideal for traditional or contemporary properties



## Heritage 'Slimline' Aluminium Windows

### The 'Alternative to Steel'

*Choices* Heritage window is designed to offer a modern aluminium replacement to the traditional steel window

The window features signature ultra slim sight lines and attractive contours.

The similarity is so close, that the window will often satisfy the exacting requirements of 'Heritage' restoration.



Slimline frame and opener only 58mm sightline



# Window Security

*Choices* provides exceptional quality and security

- A** Die cast keep to retain locking mushrooms and provide night vent facility
- B** Locking designed for optimal security and compression
- C** Security glazing which benefits from the strength of laminated glass (optional)
- D** High strength steel mushrooms
- E** Hinge protectors for additional security (optional)
- F** Internally beaded for added security
- G** Cranked handle (optional) easy to use, offset design with push button release

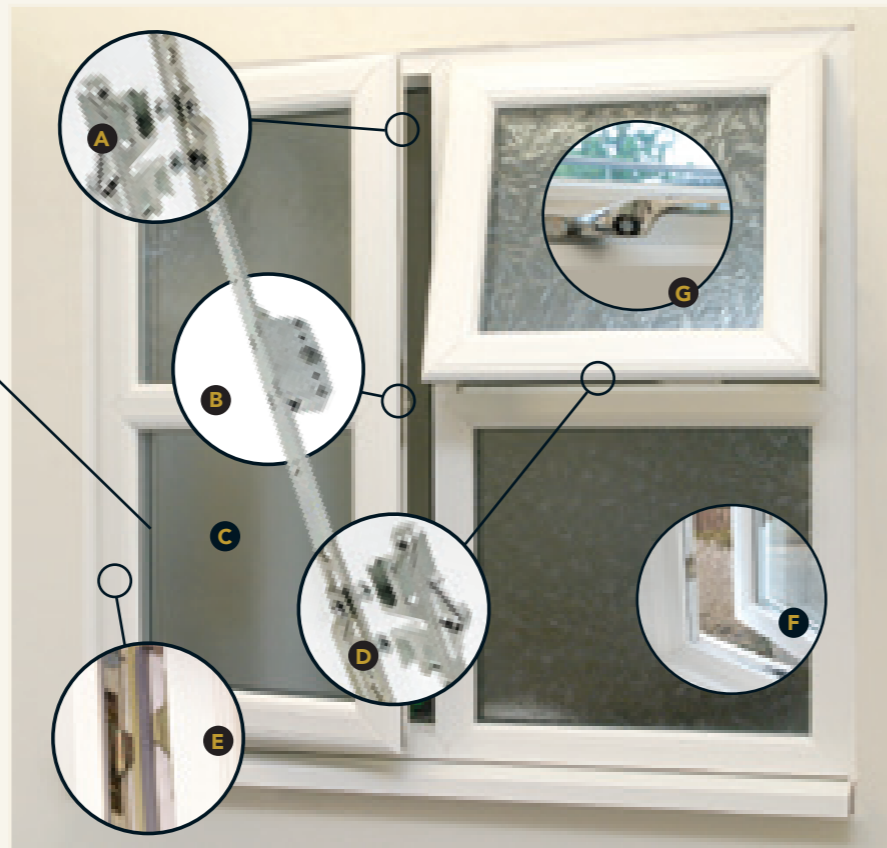

Kömmerring windows are now Kubu ready\*



Upgrade available to PAS 24 Secured by Design\*  
See window standards below

# Escape Routes

*Choices* provides exceptional quality as standard



French Windows are excitingly different and certainly contemporary, yet with classical good looks. Both sides open fully leaving a clear, unobstructed opening. This gives an easy escape route should there ever be an emergency.



Tilt and Turn windows have built in versatility. Turn the handle and the window tilts inwards for ventilation.

Turn the handle further and the window hinges inwards for ease of cleaning and escape should there be an emergency.

Escape/easy clean hinges provide an escape route and the facility to clean the exterior from the safety of the room.

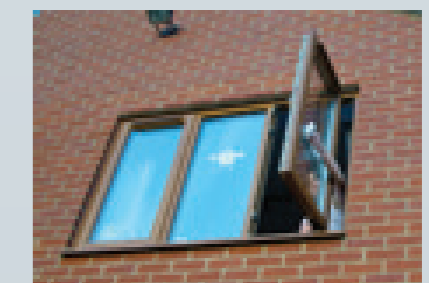
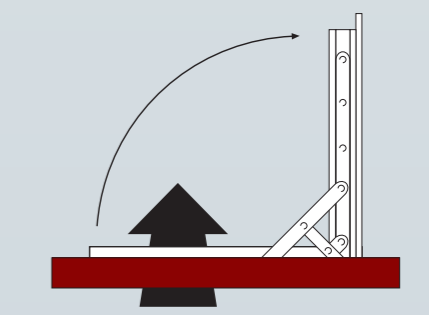

Easy Clean

## Ventilation

If working under the strictures of 'Building Regulations' ie New Build including extensions, then Rapid Ventilation must be incorporated. This means that the 'clear area' created by open windows must not be less than one twentieth of the floor area. Again, in 'New Build, situations 'background ventilation' must be incorporated – usually by 'trickle vents'.



## Child Safety

With *Choices* you have the option of an effective window safety device that cannot be disengaged accidentally



## Structural Integrity

*Choices* products are expertly crafted, combined with the most advanced technology and designs

Impact resistant, multi-chamber PVCU profiles are engineered for strength and where appropriate, are reinforced with galvanised steel.

You can be confident in every application whether it's a custom built conservatory or a super strong jacking system for bay windows and coupled frames.

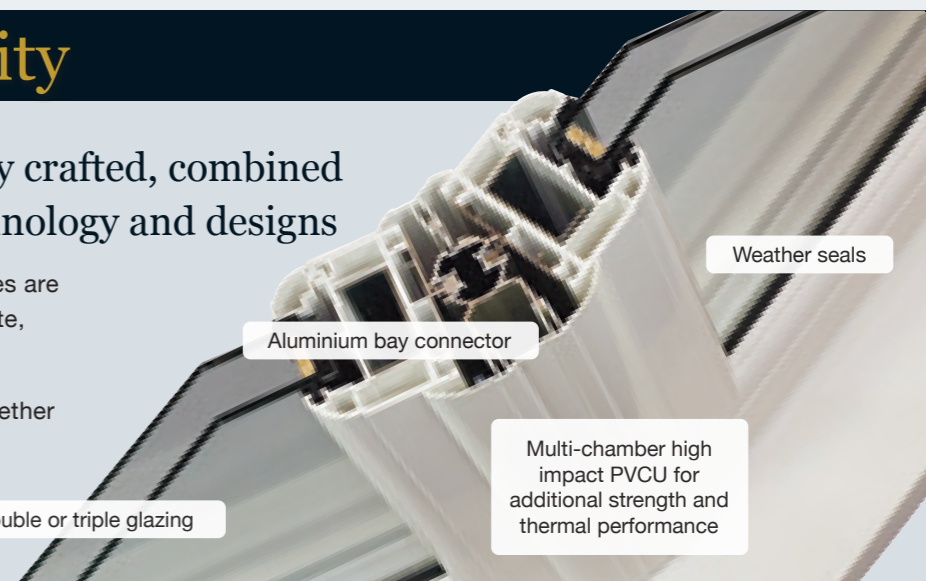

Weather seals

Aluminium bay connector

Double or triple glazing

Multi-chamber high impact PVCU for additional strength and thermal performance

## Standards

*Choices* believe in working to not only high standards – but measurable high standards

To this end, *Choices* takes its accreditation in management and manufacturing very seriously. This ensures that you are getting a product with proven performance at whatever level.



Upgrade to PAS 24 / Secured by Design\*

Secured by Design can sometimes require one laminate skin, this decision is made by the client and the police advisor.

\*Authorised re-seller of SBD products from CWG Choices Ltd.



PAS 24

Windows manufactured for enhanced security.



PAS 24

Doors manufactured for enhanced security.



BS EN ISO 9001:2015

Production operates under the auspices of BS EN ISO 9001:2000 the international standard for quality management.



BS 6206  
BS 6262  
CEN 1279-2

Glass & Glazing

Glass supplied is to BS 6206 - safety glass & BS 6206:Code of Practice plus CEN 1279-2 for sealed unit performance.

Accreditations attributed to CWG Choices Ltd and its suppliers



# Choices takes glass seriously

Many think that glass is just for looking through - it is - but also for much much more!

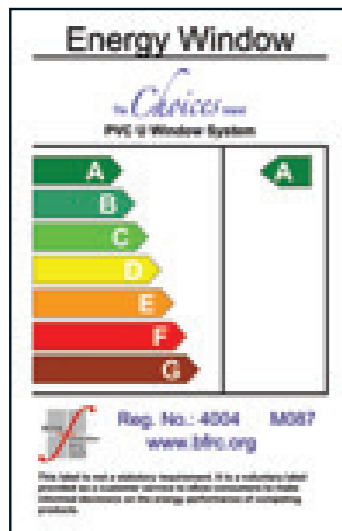

## Choices products are energy efficient

The benefit of choosing the Choices range of windows is the high specification glazing that comes with them.

Choices use high standard glazing in all their windows and doors and all Choices 70mm PVCU standard windows are 'A' Energy Rated as standard.

Choices deliver the highest possible window energy ratings. By using Choices you are able to minimise heat loss and so help reduce your heating bills. You will have peace of mind knowing that you have glazing of the highest performance virtually eliminating condensation and draughts.

## Triple glazing for enhanced energy saving



To further minimise the heat loss through your glass, there is 'triple glazing'. This means reduced heat loss and less heat input, so reduced heating bills.

Your 'feel good' factor is enhanced in that you know you are doing all you can to reduce your carbon footprint, so helping save the planet.



## ComfortClear 'Ultra4' upgrade to a quieter, safer and more habitable home

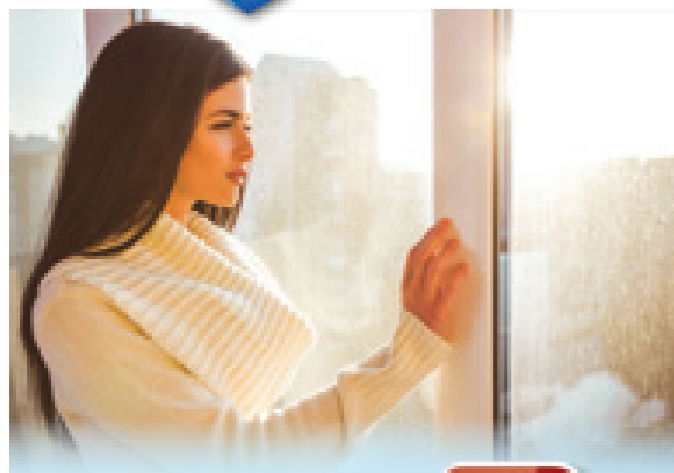

### Thermal Performance Glazing



'Ultra4' offers the same great thermal performance as Choices high specification 'A' rated windows.

A special microscopic coating on the glass helps to reflect heat back into your room offering savings of up to 22% on energy bills versus single glazing.

With up to 26% of all heat from homes being lost through the windows, choosing the right windows and glass is an easy way to make your home warmer.



### Noise Control Glazing



Making our homes free from unwanted noise is important for all of us. 'Ultra4' is specially designed with a transparent sound absorbing layer built into the glass and is 20% better than Choices standard glazing at reducing sound.

Upgrading to 'Ultra4' will reduce the noise heard from cars, neighbours, planes and many other things that bring unwanted noise into your home.



### High Security Glazing



A safe home is critical, upgrading to 'Ultra4' will provide you with peace of mind and make your home more secure.

A very strong transparent film is glued between two layers of thin glass making it much harder to break than Choices standard glass. If there is an accident the film holds any broken glass in place and avoids it shattering on the floor



### Furniture Fade Protection



How many times have you seen your furniture fade from years of exposure to the sun. This is a result of the UV light from the sun which will fade carpets, sofas and curtains. Reducing the effects of these UV rays helps your carpets & furniture stay looking new for longer.

Upgrading to 'Ultra4' will block 99.6% of the UV rays that fade furniture.

# Decorative Glazing - Enhance the look

# Hardware

## Astragal Bars

Available in all colours. Externally and internally fitted on the surface of the glass, giving an authentic look and feel to any window, door or conservatory.



25mm Astragal Bar

50mm and 25mm Astragal Bar Combination

Astragal Bar Combination

## Internal Georgian Bars

Internal Georgian Bars are internally fitted inside the glass and are available in 18mm or 25mm. Various styles include single bars, grids, curved hoops and even gold effect.



White 18mm Georgian Bar

Brown 18mm Georgian Bar

White 18mm Georgian Bar

## Lead Work

Standard or antique handcrafted lead work is available in diamond, rectangular, queen anne and decorative colour bespoke designs.



9mm Square Lead

9mm Diamond Lead

Bespoke Leadwork

## Inline Window Handles



White

Black

Hardex Gold

Hardex Chrome

Hardex Bronze

Hardex Satin

Hardex Graphite

Antique Black

## Cranked Window Handles



White

Black

Hardex Gold

Hardex Chrome

Hardex Bronze

Hardex Satin

Hardex Graphite

Antique Black

## Traditional Handles



Antique Black Monkey Tail

Hardex Gold Monkey Tail

Hardex Chrome Monkey Tail

Hardex Graphite Monkey Tail

Elegance Range Matching Functional Stay (Flush 100 only)

Elegance Range Matching Dummy Stay

Antique Black Tear Drop

Hardex Gold Tear Drop

Hardex Chrome Tear Drop

Hardex Graphite Tear Drop

Tear Drop Range Matching Functional Stay (Flush 100 only)

Tear Drop Range Matching Dummy Stay



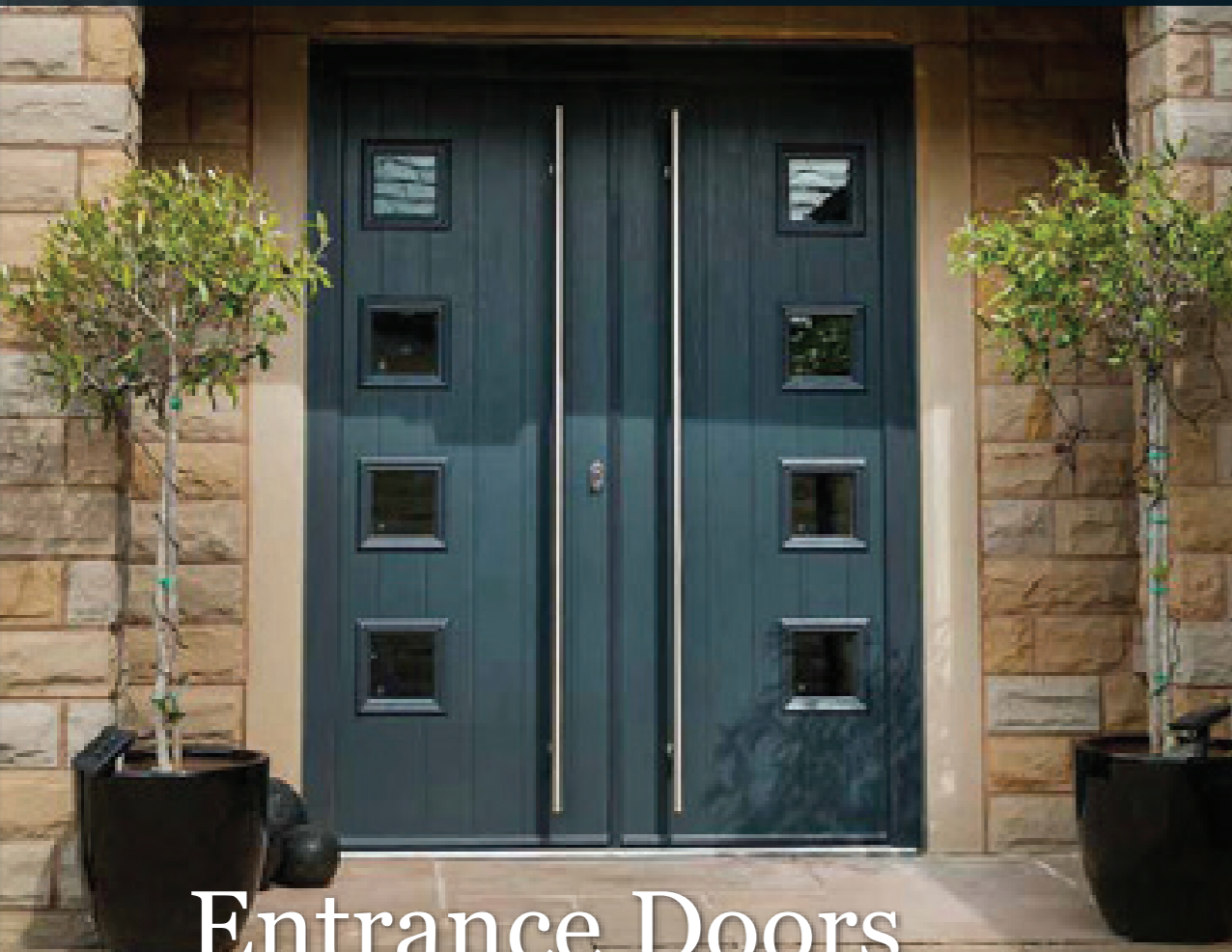

# Entrance Doors

PVCU - Aluminium - Composite  
Doors to suit any opening

Back doors, front doors, the ultra strong composite doors, sliding patio doors, stable doors, french doors or bi-folding doors which can give clear openings up to 6 metres in width - Doors to suit just about any situation.



Entrance Doors



Back Doors

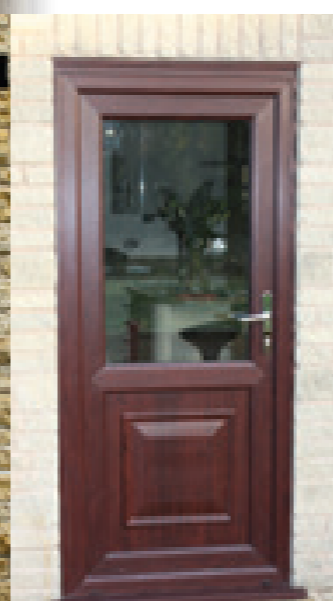

Stable Doors



French Doors



Patio Sliding Doors



Bi-Folding Doors

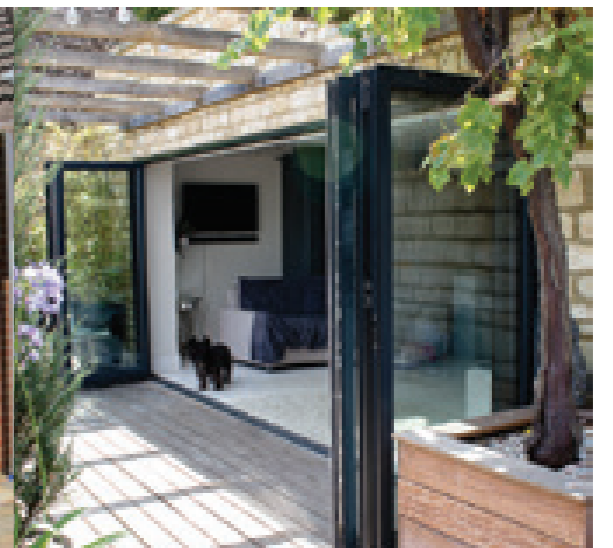

# Door Security

- A** ULTION cylinder
- B** Hook claws top and bottom operate in reverse directions for anti-lift
- C** Roller cams (optional) provide additional compression to ensure a reliable weatherproof seal
- D** Kubu ready\* (Kömmerling doors) works with 
- E** Adjustable Dynamic hinge in a choice of 9 colours
- F** Strong one piece keeps combine with hook claws to provide highly secure locking and non corrosive long lasting performance
- G** 25mm deep throw direct drive centre compressions deadbolt provides high level of security in the centre of door
- H** Steel shootbolts as standard on both leaves



\*Kubu smart kit purchase required by home owner

**Top & Bottom Hook Claws**  
Reverse hook bolts for anti-lift. Assists door compression. Provides a high level of security against attack.

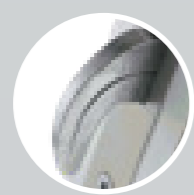

**Centre Deadbolt**  
Smooth locking operation that provides an extra level of security in centre of door. Same lock will suit Lever/Pad or Lever/Lever.



**Roller Cams**  
Provides a weatherproof seal and offers additional security by tightly binding the door sash and frame together.

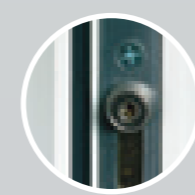

- I** ULTION cylinder
- J** Pad handle (optional) on the outside
- K** Dynamic hinge available in 9 colours ranging from White, Black, Chrome, Satin and Brown
- L** Mobility threshold (optional) provides easy access

Secured by Design (optional)  
Subject to the addition of 6.8mm laminate glazing and 3 star ULTION cylinder



Official Police Security Initiative  
\*Authorised re-seller of SBD products from CWG Choices Ltd.

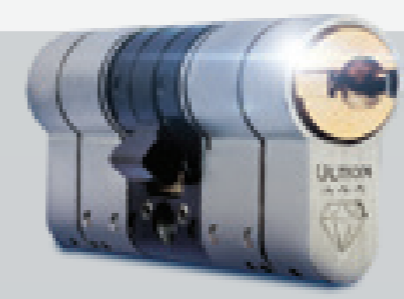

**ULTION DIAMOND cylinder upgrade**  
Ultion cylinders are available to fit to any new Choices single, double or bi-fold door and can be retrofitted to existing Choices doors  
The basis of the high security is the Molybdenum Alloy Core (Centre section) which as soon as the lock comes under attack, goes into 'Lockdown Mode'. The first two sections are designed to 'snap' off – then the attacker will be confronted with the high security 'core'.



Make the most of the room with a view to enjoy all year round

## PVCU Range



### Bi-Folding Doors

*Choices* PVCU Bi-folds combining the rigidity of aluminium and the aesthetics of timber.

Its attention to detail in design, security and thermal performance all combine to make it a truly innovative way to transform any room. All door leaves fold flat to the inside or the outside of the opening providing maximum clear opening space.

The perfect addition to any home to help divide a room, open up onto a terrace or conservatory - or for simply enjoying panoramic views.



### Premiline PVCU Patio Doors with smooth sliding operation and stylish looks

The *Choices* Premiline Sliding Patio door is available in 2, 3 or 4 pane configurations.

## ALUMINIUM Range

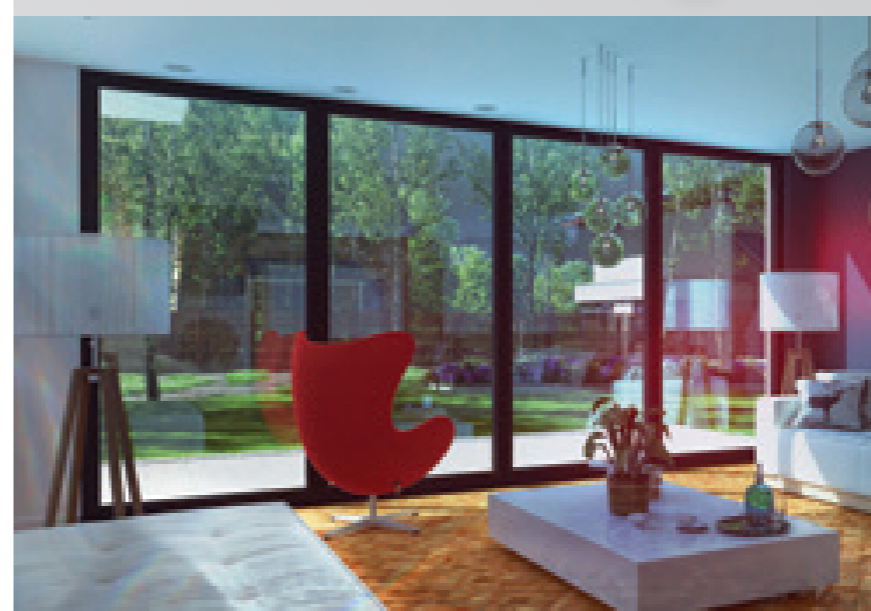

### Bi-Folding Doors

*Choices* Aluminium Bi-folding doors create flexible and modern living spaces, whether you want to use them internally or externally.

Our bespoke designs perfectly match the existing style of your home, allowing natural light to flood in whilst providing the opportunity to bring the outdoors, indoors.

*Choices* Cornerless Bi-folding Doors offer the ultimate uninterrupted view, inside and outside of any room.



### Patio Doors

The Aluminium sliding door is a multi-configuration in-line system that allows you to specify and design the most suitable solution for your project.

The system is available with fixed lights or sliding doors, as well as double and triple track options. Outstanding thermal performance and the highest quality fittings ensure reliable and comfortable operation.



# 'Alternative to Timber' Doors



## Residence Collection

### Flush Sash Doors

Put simply *Choices* Flush doors are designed to replicate traditional timber doors with flush fitting sashes. With their authentic slimline appearance they offer the perfect match in design and colour to the *Choices* Flush Casement window range.

Available as open-in or open-out (for flush out) single and double doors. Options include low aluminium threshold, full height glass panels and traditional georgian bars. With handles to both leaves on double doors, *Choices* Flush doors will be a welcome addition to any home.



Flush Fitting Sashes

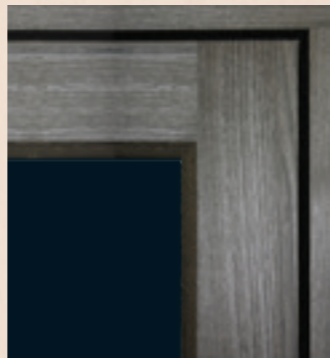

Optional Mechanical Joints



## 'Alternative to Timber' Doors

### Period Style Doors



*Choices* 'Alternative To Timber' doors are traditional looking doors manufactured utilising modern materials and techniques to look like timber.

Available as single and double doors, they are expertly handcrafted with mechanically jointed midrails and mullions to create authentic timber appearances.



Solidor.

Residor.

## Composite Doors

### Durability with modern technology

*Choices* Solidors look and feel just like natural wooden doors but offer all the benefits and security of a modern product. Available with optional side panels and there is also the option for a french door combination.

Each composite door is constructed with a solid timber core and a high security locking as standard, thus providing peace of mind for the security of your home.

### Design Features



Solid Timber Core



Traditional Hardware



Traditional looks



Stable Door Option

## 'Imagine' Single & Double Doors

A stunning range of traditional looking open-in or open-out doors, their unique design means there is no requirement for a floating mullion on double doors.

With flush fitting sashes on open out doors, improved appearance and slimmer sightlines are assured.





# Choices Conservatories

What do you want your conservatory to be?

## Benefits of enhancing a *Choices* conservatory with a glass roof:

- ✓ Excellent thermal insulation reducing energy costs
- ✓ Warmer in winter months
- ✓ Cooler in summer months
- ✓ Dual action 'self clean' glass
- ✓ Reduced solar heat gain
- ✓ Reduced noise interference

## Easy clean glass

The special coating reacts with daylight to break down organic dirt. When water hits the glass instead of forming droplets it spreads evenly, running off in a "sheet" and taking the loosened dirt with it.



## Customise with colour

Why stick to the traditional white conservatory when colour is readily available to suit your style and taste.

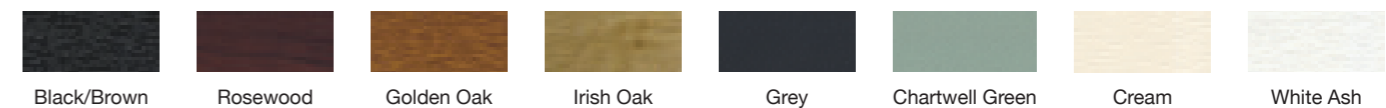

## Lounge, Dining Room or Games Area?

...A meeting room or study, a place to sit, to relax, or to enjoy. A comfortable place, a place of peace, to meet with friends or family, a place that is as versatile and as adaptable as you choose.

Attractive and Versatile lifestyle choice!

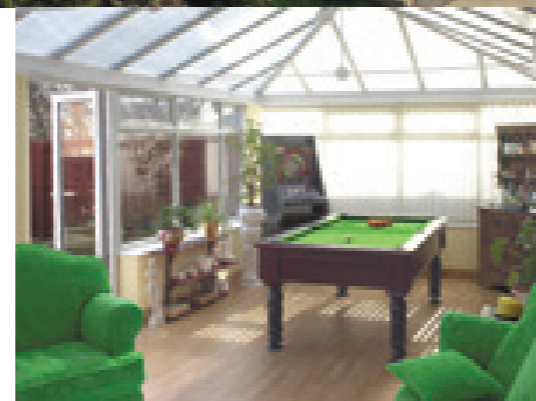

## What size or style?

*Choices* Conservatories are available in a wide range of styles, sizes and finishes with options that will meet most requirements.

### Frame Styles



### Conservatory Styles





# Orangeries and Garden Rooms

A new era in Conservatory Design

**Orangeries and Garden Rooms are the latest developments in the conservatory market**

Combining the best of both worlds, with the light and glass of a conservatory and the walls and ceiling of an extension. Mimicking a traditional atrium style conservatory, with all the benefits of the latest technology.



## 'Livin Room' Orangeries

Based on traditional building technologies 'Livin Room' Orangeries add a touch of contemporary style to any home, bridging the gap between a conservatory and an extension.



'Livin Room' roof with optional cornice detail



Aluminium bi-folding doors with Internal pelmet design



# Choices Timber

An extensive range to meet your needs

## High performance windows and doors

Manufactured from the highest quality hardwood or engineered softwood our timber window range includes flush sash, storm casements, vertical sliding sash windows, tilt and turns and timber aluminium clad windows.

To compliment the windows our timber door range offers elegant single doors, french double doors and smooth sliding doors providing unbroken sightlines, coupled with almost an endless choice of design, colour and stain options



Scotdoors



Traditional Sliding Sash



Modern Alu Clad



Bi-folding Doors

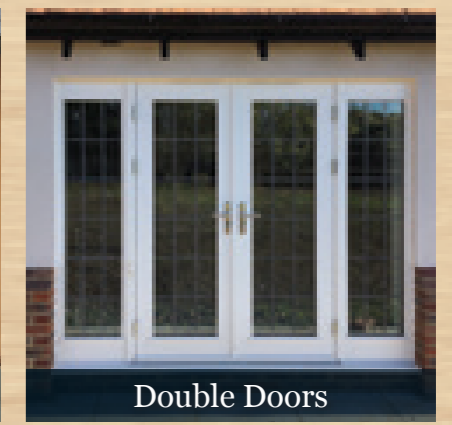

Double Doors



Modern • Traditional • Innovative



Windows, Doors and Conservatories

The *Choices* brand

Windows, Doors, Conservatories