



CWG Choices Ltd.

# PRODUCT GUIDE 2025



PVCU • ALUMINIUM • TIMBER • ALU CLAD







# Choices

# The Choices brand

The brand that allows you to let your imagination run wild with energy efficient windows and doors.

Whether you are looking for the traditional or modern appearance, in PVCU, Aluminium, Timber or Aluminium Clad Timber along with all the options of colour, hardware and glazing, you will find it with CWG Choices.

**PVCU • ALUMINIUM • TIMBER • ALU CLAD**

## PRODUCT INDEX

Kömmerring System.....	4-5
Kömmerring Legacy.....	6-7
Kömmerring Flush 70.....	8-9
Halo Flush 70.....	10-11
Timberweld.....	12-13
Residence 7.....	14-15
Residence 9.....	16-17
Residence 2.....	18-19
Vertical Sliding Sashes.....	20-21
RunThru Horns.....	22-23
Window Hardware.....	24-25
Window Specification / Energy Ratings.....	26
Astragal Bars / Radlington Cill.....	27
Kubu Smart Technology.....	28-29
Ultion.....	30-31
Alternative to Timber Doors.....	32-33
Residor.....	34-35
Solidor.....	36-37
PremiLine Sliding Patio Doors.....	38-39
Imagine PVCU Doors.....	40-41
Imagine PVCU Bi-fold.....	42-43
Residence Doors.....	44-45
Door Specification / Hardware.....	46-47

PVCU



ALUK 58BW HI Windows.....	48-49
ALUK Heritage ST HI 58BW Windows & 58BD Doors.....	50-51
ALUK 58BD HI Door System.....	52-53
ALUK S67 Slim In-Line Sliding Door.....	54-55
ALUK S140 Lift & Slide Door.....	56-57
ALUK Bi-Fold BSF70 HI.....	58-59
ALUK GT55 TB Commercial Door System.....	60-61
Aluminium Designer Door Range.....	62-63
Inotherm.....	64-65
SecureRoll Garage Doors.....	66-67

ALUMINIUM



Timber Casement Windows.....	68-69
Timber Vertical Sliding Sash Windows.....	70-71
Timber Scotdoor.....	72-75
Timber Single and Double Doors.....	76-77
FD30s Fire Doors.....	78-79
Alu Clad Timber.....	80-81

TIMBER

WARMroof, Rooflights & Lanterns.....	82-83
Ultra4.....	84
Glazing Enhancements.....	85
Konig Repair Kits.....	86-87



## 70mm Window and Door Systems



### Choices

#### The UK's largest supplier

Kömmerring is a versatile 70mm product range available in a wide range of colours, Astragal bar options and double or triple glazed.



See pages 28-29



### Colour Options On White base unless otherwise stated

Both sides			Both sides grained or on smooth white				On smooth white					Both sides
White Ash	Cream	Irish Oak	Golden Oak	Rosewood	Black/Brown	Grained Anthracite Grey (C70)	Smooth Anthracite Grey (C70)	Grained Anthracite Grey	Chartwell Green	Smooth Textured Slate Grey (C70 only)	Painswick Grey (C70 only)	Smooth Anthracite Grey (C70)
<small>White base</small>		<small>Caramel base</small>		<small>Black/Brown base</small>			<small>White base</small>					<small>Grey base</small>

✓ 'A' Energy Rated    ✓ U-value of 1.4W/m<sup>2</sup>k, 1.2 with Low-E Plus Glass

### Upgrade to PAS 24 Secured by Design

Easy and Inexpensive



Secured by Design



Police Preferred Specification

Meets the requirements of Document Q

### Maximum Sizes

**Side Hung**  
Width = 650mm  
Height = 1325mm

**Top hung**  
Width = 1100mm  
Height = 1100mm  
Maximum 1m<sup>2</sup>

### Triple Glazing Upgrade

All 70mm Kömmerring windows available with 36mm or 40mm triple glazing upgrade

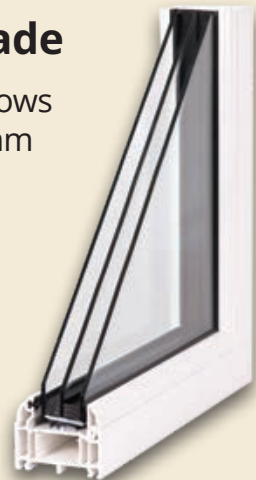

### Recommended O/A Maximum Sizes

Side hung = 750mm (w) 1400mm (h)  
Top hung = 1350mm (w) 1250mm (h) / Maximum 1m<sup>2</sup>

### Three Astragal Bar Options



21mm



25mm

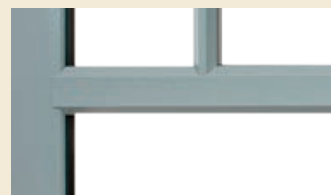

50mm

# Kömmerring



**O70**  
Fully Sculptured



**C70**  
Chamfered



**Flush 70**



**C70**  
Slim Sash



**Legacy**  
Sculptured inside  
Chamfered Outside

### Gasket colour options for non foiled white



O70 Standard - black gasket/black warmedge spacer  
Option - silver gasket/white warmedge spacer\*

C70 Standard - black gasket/black warmedge spacer  
Option - silver gasket/white warmedge spacer\*

Flush Standard - black gasket only

All foils have black gasket and either black (default) or white warmedge spacer\*

\*Subject to availability



**A**  
Energy Rated

**1.4**  
Double Glazed

**1.2**  
With Low-E Plus



# Legacy



See pages 28-29

## Choices

The 70mm LEGACY Storm Casement windows offer the best of both worlds – Look and feel like timber and have all the benefits of modern slim sash technology. Legacy 'Alternative to Timber' windows offer the ideal solution when windows need replacing.

## Designed with timber features in mind



Putty line external chamber finish with 154mm slim sash / mullion / sash sightline



Arris joints mimicking traditional timber joinery



C70 slim sash with Astragal bar upgrade



Mechanical jointed transoms and mullions

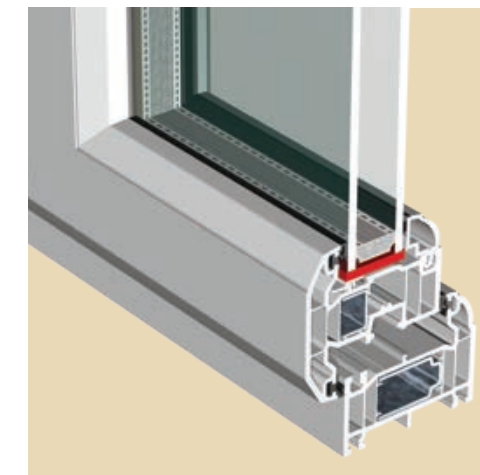

70mm frame for double or 36 / 40mm triple glazing

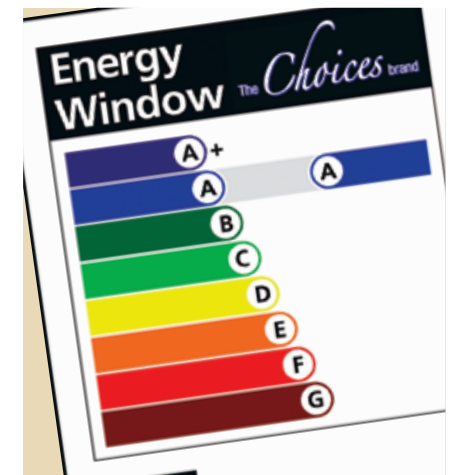

A Energy Rated - A+ Available

# Legacy

## from the 'Alternative to Timber' Collection

Looks Like Timber - Feels Like Timber

### Legacy Features:

- ✓ Kömmerling O70 fully sculptured outer frame, ensuring a close match to a traditional timber window
- ✓ Kömmerling C70 "slim line" sash
- ✓ All transoms & mullions are mechanically jointed with arris detail giving the appearance of timber joints
- ✓ 5 chambered lead free profile
- ✓ Traditional furniture options
- ✓ 'A' Energy Rated
- ✓ U-value of 1.4 W/m<sup>2</sup>k, 1.2 with Low-E Plus glass
- ✓ Available 'A+' Energy Rated with 40mm Triple Glazing
- ✓ Equal sightlines



### Colour Options

Both sides or on smooth white

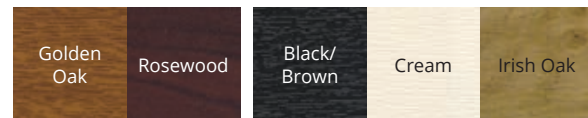

Both sides only

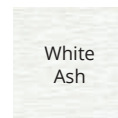

On smooth white only

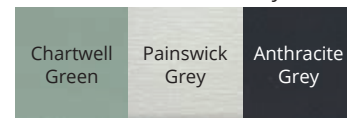

Special colour combinations available upon request and extended lead times

### Standard



Inline

### Handles



Cranked. Monkey Tail or Tear Drop

### Upgrades



Dummy Stays

ALL HANDLES SEE PAGES 24-25



**A**  
Energy Rated

**1.4**  
Double Glazed  
**1.2**  
With Low-E Plus



# Kommerling Flush 70



See pages 28-29

## Choices

'Flush 70' combines modern performance with traditional flush casement design offering authenticity without compromise.

## Designed with timber features in mind

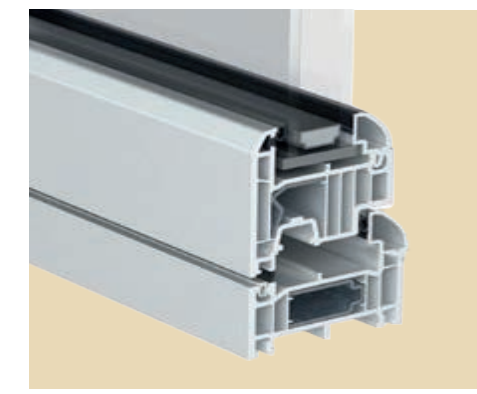

6 chambered sash for high thermal efficiency and sound reduction



Dummy stays



Decorative Internal finish



Astragal bar upgrade



# Kommerling Flush 70

## from the 'Alternative to Timber' Collection

Looks Like Timber - Feels Like Timber

### Specification:

- ✓ 70mm welded outer frame
- ✓ Flush fitted welded sashes
- ✓ Equal sightlines with Dummy Sashes
- ✓ Multichambered outerframe
- ✓ 6 chamber sash
- ✓ 'A' Energy Rated
- ✓ U-value of 1.4W/m<sup>2</sup>k, 1.2 with Low-E Plus glass
- ✓ Available 'A+' Energy Rated with 40mm Triple Glazing
- ✓ Traditional and modern glazing bead options from 28mm to 40mm as standard



Standard

Inline

### Handles

Cranked. Monkey Tail or Tear Drop

Upgrades

Dummy Stays

ALL HANDLES SEE PAGES 24-25

## Colour Options On White base unless otherwise stated

<small>Both sides or on smooth white</small>	<small>Both sides</small>	<small>Both sides</small>	<small>On smooth white</small>	<small>On smooth white</small>
Flat White	White Ash	Irish Oak	Smooth Anthracite Grey*	Irish Oak
Cream		Golden Oak		Golden Oak
		Black Brown		Black Brown
				Chartwell Green
				Anthracite Grey (Grained)
				Painswick Grey
	<small>Caramel base</small>	<small>Black/Brown base</small>	<small>*Extended Lead Time</small>	



**A**  
Energy Rated

**1.4**  
Double Glazed  
**1.2**  
With Low-E Plus



# Halo Flush 70



## Choices

'Flush 70' combines modern performance with traditional flush casement design offering authenticity without compromise.

### Designed with timber features in mind



Flush fitting sashes



Arrisred joints mimicking traditional timber joinery



Full mechanical joint upgrade 162mm sash / mullion / sash sightline

# Halo Flush 70

from the 'Alternative to Timber' Collection

*Looks Like Timber - Feels Like Timber*



Zero sightline mullion or transom upgrade

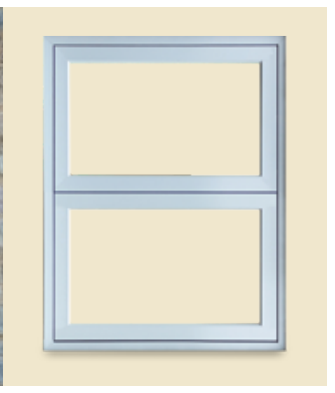

Astragal bar upgrade

### Specification:

- ✓ 70mm welded outer frame
- ✓ Flush fitted welded sashes
- ✓ Mechanically jointed transoms and mullions with arris detail as standard
- ✓ Equal sightlines with Dummy Sashes
- ✓ Multichambered outerframe
- ✓ 'A' Energy Rated
- ✓ U-value of 1.4W/m<sup>2</sup>k, 1.2 with Low-E Plus glass
- ✓ Full Mechanical Joint Upgrade Option

**UPGRADE**  
**PAS 24**  
**DOC Q**



### Colour Options

Both sides or on smooth white							Both sides only (white base)	On White Ash (white base)	On smooth white only	
Golden Oak	Rosewood*	Beck Brown	Cream	Irish Oak	Anthracite Grey (Grained)	White Ash	*Silver Grey RAL 7001	Cream	Chartwell Green	Painswick Grey
*Veka Rosewood & Black/Brown foils do not match the Rosewood & Black/Brown foils of the other profiles								Beck/Brown	*Anthracite Grey (Smooth Textured)	*Slate Grey RAL 7015
Golden Oak/Golden Oak, Beck Brown/Beck Brown, Rosewood/Rosewood and Irish Oak/Irish Oak on Brown Base										





# Timberweld® Advantages

Elevate the appearance of windows with the benefits of timberweld

- ✓ Captures the timeless appeal of original timber sash windows seamlessly.
- ✓ Patented technology ensures impeccable craftsmanship and premium finished products.
- ✓ Eliminates visible welds for a flawless, authentic look.
- ✓ Delivers superior aesthetics with wood-grained finishes.
- ✓ Enhances performance, strength, and durability.
- ✓ Available factory glazed or loose glazed.



# Timberweld®

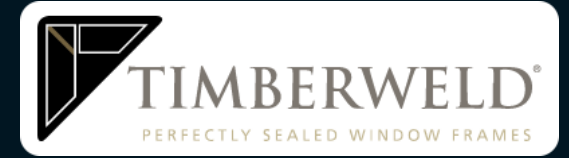

## Choices

**Perfectly sealed, authentic looking timber joints**

Bid farewell to mechanical joints and embrace the impeccable artistry of Timberweld® while maintaining top-notch performance and aesthetics.

This innovative, patented technique delivers authentic timber joints that grace both the Sash and Frame.

The process produces premium finished products that closely resemble the traditional charm of timber joints on the entire "Residence Collection" from CWG.



## Timberweld® Videos

Timberweld® from CWG Choices



<https://cwgchoices.com/timberweld1>

Timberweld® Versus Mechanical Joints



<https://cwgchoices.com/timberweld2>

## The Timberweld® Process

**Experience the future of PVCU joinery with Timberweld®, an innovative process that creates flawless, seamless joints, evoking the classic appeal of timber windows.**

Patented technology ensures premium aesthetics, superior performance, and timeless elegance in every product.

Step 1

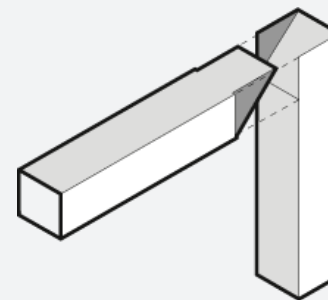

TIMBERWELD® is unique and patented method of joining two sections.

Step 2

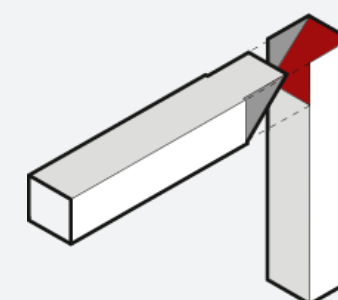

Profiles are cut to size, then ends milled before being welded or joined.

Step 3

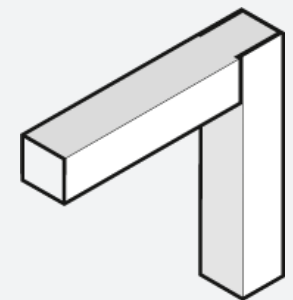

No holes, just perfectly sealed corners.

## 'Choices' Residence Collection

The 'Choices' Residence Collection are all available Timberwelded.

By combining the timeless aesthetics of the Residence Collection with the flawless craftsmanship of Timberweld®, homeowners can enjoy the authentic charm of traditional timber windows without any visible welds.



Residence 9



Residence 7



Residence 2



Residence Doors



**A+**  
Energy Rating  
Available with  
44mm Triple  
Glazing

**1.2**  
Double Glazed  
**0.8**  
Triple Glazed



# Residence 7



## Choices

'Residence 7' offers the same great external finish as 'Residence 9', but has been designed with a flush finish internally, ideal for replacing modern 70mm systems.



Timberweld jointed sash and outer frame



Dummy butt hinge upgrade (Functional butt hinges not available)



Flush external finishes with equal sightline

# Residence 7

from the 'Alternative to Timber' Collection

Looks Like Timber - Feels Like Timber



External transom bar upgrade



Flush internal/external finishes  
Dummy stays available



55mm Radlington cill option

### Colours Windows and Open Out Doors

Both sides only



Chalk white is unfoiled  
NB: No dual foil option.  
Rebates not foiled.

### Open in Doors only

Both sides only

Both sides or on chalk white

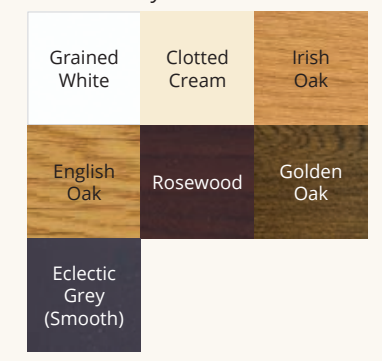

On chalk white only



Unfoiled matt finish both sides



Unfoiled matt finish both sides

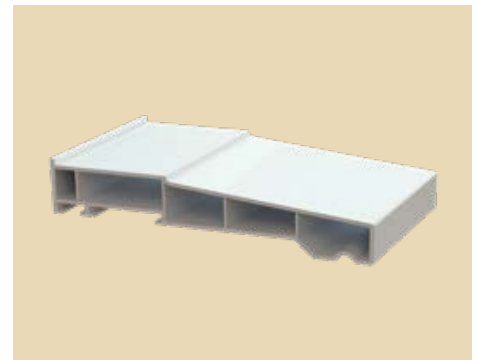

30mm upstand x 165mm Radlington cill  
Fitted as standard to R7



20mm Astragal and 60mm Transom bar upgrade

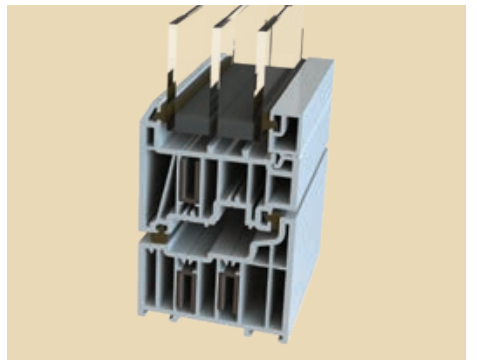

75mm system for 28mm double glazing or 44mm for triple glazing

UPGRADE  
**PAS 24 DOC Q**



ALL HANDLES SEE PAGES 24-25





**A+**  
Energy Rating  
Available with  
44mm Triple  
Glazing

**1.2**  
Double Glazed  
**0.8**  
Triple Glazed



# Residence 9



## Choices

Residence 9 'Alternative to Timber' range is specifically designed to replicate 19th century timber windows and doors. With a flush external casement design and a decorative internal finish they are ideal when replacing 100mm traditional timber windows. A choice of styling options make them suitable for period and modern properties. Supplied Timberwelded as standard.



# Residence 9

from the 'Alternative to Timber' Collection

*Looks Like Timber - Feels Like Timber*



Timberweld jointed sash and outer frame



20mm Astragal and 60mm Transom bar upgrade



Flush external finishes with equal sightline and external transom bar upgrade

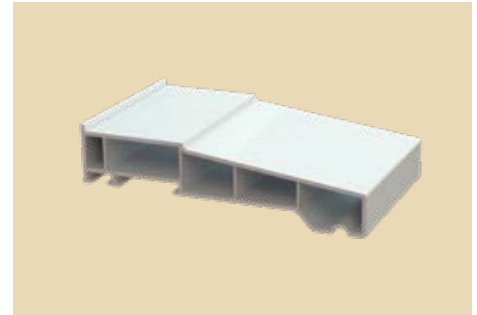

30mm upstand x 165mm Radlington cill Fitted as standard to R9



Dual foil upgrades. Foiled through the rebate as standard



100mm outer frame for 28mm double glazing or 44mm triple glazing



Dummy or functional stays upgrade

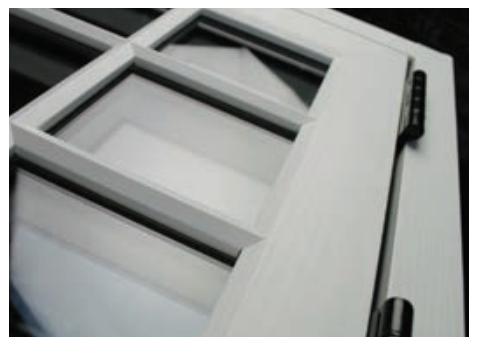

Dummy or functional butt hinges upgrade



55mm Radlington cill option



### Colours

**Windows and Open Out Doors**

Both sides only

Grained White			
Both sides or on grained white			
Clotted Cream	Eclectic Grey (Smooth)	Painswick Grey	Cotswold Biscuit (Ivory)
English Oak	Irish Oak	Silvered Oak	Cotswold Green

### Open in Doors only

Both sides only

Grained White	Clotted Cream	Silvered Oak
Eclectic Grey (Smooth)	Irish Oak	English Oak

Dual foil

Painswick Grey	No. 10 Black	No. 10 Black
Clotted Cream	Cotswold Biscuit	Grained White
Eclectic Grey	No. 10 Black	Corse Lawn Grey
English Oak	English Oak	Grained White



Astragal Bar Grids supplied Fully Glazed

**UPGRADE PAS 24 DOC Q**



ALL HANDLES SEE PAGES 24-25



**A+**  
Energy Rating  
Available with  
44mm Triple  
Glazing

**1.2**  
Double Glazed  
**0.8**  
Triple Glazed



# Residence<sup>2</sup>



## Choices

Residence<sup>2</sup> is the architectural highlight of the Residence Collection, with clean lines and superb energy performance.

With a flush external casement design and a square edge internal finish they are ideal for contemporary, energy efficient applications. A choice of styling options make them suitable for period and modern properties.

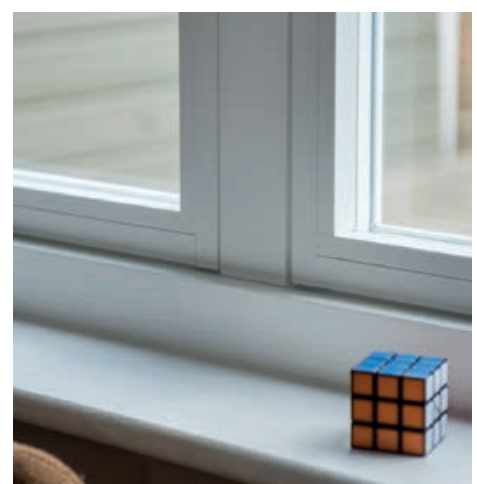

Timberweld jointed sash and outer frame



Straight lined innovation, bold looks create a bright living environment



100mm 9 chambered energy efficient profile achieving 0.8 W/m<sup>2</sup>k U-Value using 44mm triple glazing

# Residence<sup>2</sup>

## from the 'Alternative to Timber' Collection

*Looks Like Timber - Feels Like Timber*



### Window and Door Colours

*For both open in and open out doors*

*Both sides only*

Grained White	Clotted Cream	Painswick Grey	English Oak
Silvered Oak	Eclectic Grey (Smooth)	Irish Oak	

*Unfoiled Matt finish both sides*

No. 38 Grey (RAL 7035)	Vintage Cream (RAL 9001)	Chalk White (RAL 9016)
------------------------	--------------------------	------------------------

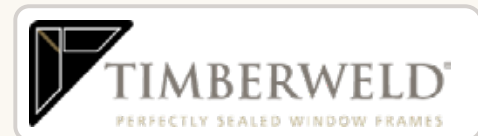

*New complementing the old Dummy or functional stays upgrade*



*Feels elegant and timeless for those wanting a contemporary look in a traditional building*



*55mm Radlington cill option*

**UPGRADE PAS 24 DOC Q**

**Handles**

*Standard* *Upgrades*

**ALL HANDLES SEE PAGES 24-25**

*Cranked* *Monkey Tail or Tear Drop* *Stays*



# Vertical Sliding Sashes

## Choices

The outstanding Imagine Vertical Sliding Sash Window is designed with timber in mind. Exceptional performance, utilising modern technology they offer traditional styling whilst maintaining authentic looks.



Lockable Latch



Tilt Button



Shark Fin Limit Stop (Optional)



Tilt Restrictors



Integrated Stub or Projecting Cill



Deep Base Rail (Standard)

### Timber replica upgrades

Mechanically Jointed



Flush RunThru Sash Horns



Astragal Bars



# imagine Vertical Sliding Sash Window

### Specification:

- ✓ Smooth white 146mm front to back profile
- ✓ Fully welded or mechanically jointed
- ✓ 'A' Energy Rated
- ✓ 28mm Softcoat float glass sealed units
- ✓ Black warmedge - Argon filled
- ✓ Internally sculptured beads
- ✓ Deep 'authentic' bottom rail - mechanically jointed
- ✓ Pre-tensioned maintenance free balances
- ✓ Sashes tilt inwards for cleaning
- ✓ Single cam lock on windows up to 800mm wide
- ✓ Double cam locks on windows 801 or over
- ✓ Lowline glazing - black gaskets
- ✓ Slim 50mm top sash
- ✓ 66mm midrail sight line
- ✓ Equal glass height as standard
- ✓ Optional 155mm integrated stub cill or 200mm projecting cill
- ✓ Virtually maintenance free
- ✓ U-value of 1.4W/m<sup>2</sup>k, 1.3 with Low-E Plus glass

### Colour Options

All foils on a white base unless otherwise stated

Both sides or on smooth white

Smooth White	White Ash	Cream	Painswick Grey	Chartwell Green	Anthracite Grey (Grained)
--------------	-----------	-------	----------------	-----------------	---------------------------

On smooth white only

Pebble Grey	Anthracite Grey (Smooth Textured)	Irish Oak
Slate Grey	Silver Grey	Beck Brown

Both sides

Golden Oak	Rosewood (Veka Foil)
------------	----------------------

on Brown Base

On smooth white

Golden Oak	Rosewood (Veka Foil)
------------	----------------------

on White Base

Dual Foil

Pebble Grey
White Ash



# RunThru Horns

Choose from three functional options, including designs that meet the requirements of Part B of Building Regulations for fire escape.



**OPTION 1**

## RunThru Horn top hung over fixed pane

Top hung windows with horns, create an attractive alternative to the traditional vertical sliding window.

Whilst this is the slimmest and most cost effective RunThru horn option, it does not meet the requirements of Part B of Building Regulations. In this instance Option 2 or 3 should be considered.



**OPTION 2**

## RunThru Horn over Tilt and Turn inwards opening window

The Upper Sash - The top hung casement provides a convenient and ready source of ventilation. It can also be locked in a night ventilation position.

The Lower Sash - The lower sash is a Tilt and Turn window and as such can be tilted inwards for ventilation. It can also be turned 90° inwards for cleaning. Dependent upon size and position it can be used for emergency escape when the opening size must meet the demands of Part B of Building Regulations.

Min 450mm in either direction. Min 0.33m<sup>2</sup>



ESCAPE

1.4  
Double Glazed  
1.2  
With Low-E  
Plus

**OPTION 3**

## The full Tilt and Turn with Dummy Sash and RunThru horns

A window designed specifically for a home owner who requires the top opener over a fixed pane style, but has to consider Part B of Building Regulations.

To match a top hung over fixed pane style window, a full Tilt & Turn sash is fitted with a fixed dummy sash with RunThru horns. The result is a fully opening window that has ventilation under normal circumstances and the escape facility if the worst should happen.

**Tilt and Turn width/height ratio = Width should not exceed 1.5 times height**



# RunThru Horns

## Choices

RunThru windows create a practical alternative to the traditional vertical sliding window.

RunThru horn windows are available in a range of styles and in particular, can provide egress solutions where required.



## RunThru horns in Kömmerling O70 and C70

### Standard Specification:

- ✓ 70mm frame depth
- ✓ 'A' Energy Rated
- ✓ Available triple glazed
- ✓ 5 chambered for enhanced thermal performance
- ✓ Wide range of foils
- ✓ U-value of 1.4W/m<sup>2</sup>k, 1.2 with Low-E plus glass
- ✓ High security multi-point locking
- ✓ Multipoint locking to casement openers
- ✓ Internally beaded
- ✓ Casement sash 76mm wide
- ✓ Lead-free PVCU profiles that are better for the environment

Full tilt and turn escape window (O70 only)



1.4  
Double Glazed  
1.2  
With Low-E  
Plus



Smooth White	Both sides or on smooth white		Both sides only		On smooth white only		Both sides	
	Rosewood	Golden Oak	White Ash	Chartwell Green	Anthracite Grey	Anthracite Grey (C70 only)		
	Black/Brown	Cream	Irish Oak					



Matching foiled end caps (O70 only)



Standard range



Standard range upgrade



Cranked range



Elegance range *Available as Monkey Tail or Tear Drop in colours shown below*

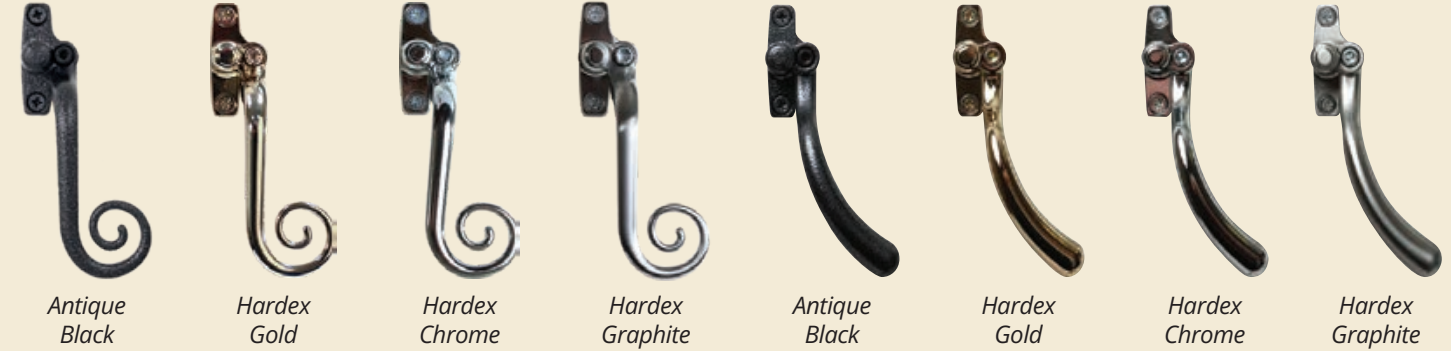

Functional and Dummy Stays



*Elegance Range Matching Functional Stay (R9 and R2 only)*



*Tear Drop Range Matching Functional Stay (R9 and R2 only)*



*Elegance Range Matching Dummy Stay*



*Tear Drop Range Matching Dummy Stay*

Trickle vents

2500EA trickle vents

5000EA trickle vents



**Concealed vents are available as:**  
White/Cream/Black/Dark Grey/Painswick/Chartwell

**Other colours (Not as concealed):** Brown/Caramel options available.  
Rosewood/Golden Oak/Irish Oak foiled vents also available  
(Foiled vents 5000EA only)

Concealed trickle vent cover/head drip

*Suitable for fitting to any 'Choices' PVCU or Aluminium product.*





## Kömmerring Windows **AVANTIS**

All 'Choices' Kömmerring windows will be supplied with high specification locking.

### Standard Specification:

- A** High strength steel mushrooms
- B** Locking designed for optimal security and compression, 7-11 locking points per sash
- C** Die cast keep to retain locking mushrooms and provide night vent facility

### Optional upgrade to PAS 24:

- D** Hinge protectors

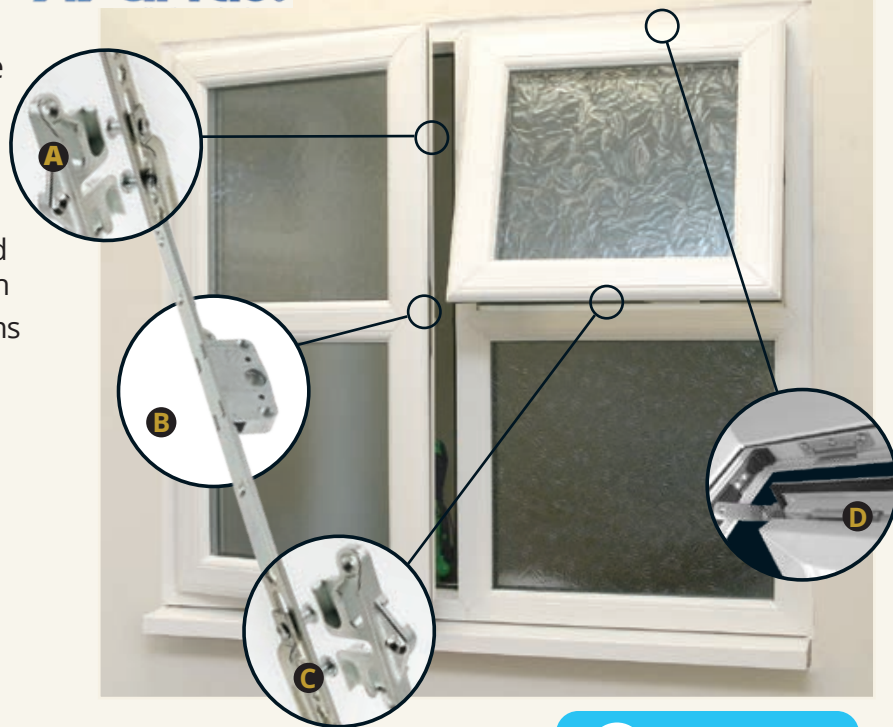

### Upgrade to PAS 24 Secured by Design Easy and Inexpensive

Secured by Design can sometimes require one laminate skin, this decision is made by the client and the police advisor.



See pages 28-29



### Energy Ratings

'Choices' windows are 'A' Energy Rated as standard where applicable



Energy Ratings - Calculation based on 'U' Value, air leakage and solar gain

### Window 'U' Values

Wide range available

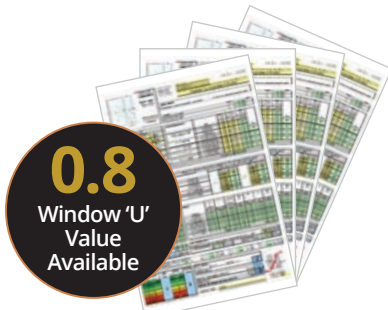

'U' Value - the measurement of thermal performance of a window

## Window Energy Ratings & Glazing Upgrades

### Window energy ratings and 'U' value chart

	Standard Casements		Tilt and Turn or Wide outer casements	
	Energy Rating	'U' Value	Energy Rating	'U' Value
Kömmerring O70/C70* - with Low-E Plus glass	A	1.4	B	1.4
Triple Glazed 36mm	A	1.1		1.1
Triple Glazed 40mm	A+	1.1		1.1
Halo Flush 70 - with Low-E Plus glass	A	1.4	B	1.4
		1.2		1.3
Kömmerring Flush Sash 70 - with Low-E Plus glass	A	1.4		
		1.2		
Residence** 9, R <sup>2</sup> and R7 Triple Glazed 44mm	A	1.2		
	A+	0.8		
Imagine Vertical Slider - with Low-E Plus glass		1.4		
		1.3		

36mm triple glazing uses a slim sculptured bead, 40mm triple glazing uses a slim flat bead.

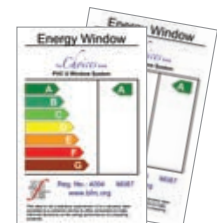

All figures shown are overall window 'U' values

\*Large outer frame casements on Kömmerring will be 'A' rated, all other systems will be the wide outer casement rating

\*\*Residence 9, R<sup>2</sup> and R7 available 'A' rated on request only

## 'Choices' Astragal Bar range

Astragal Bars can be fitted to most of the windows and doors within the Choices PVCU range

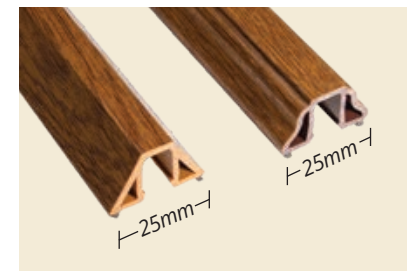

### 25mm ASTRAGAL BAR

for Kömmerring O70 and C70.

25mm clip fit Astragal bar with milled ends to match profile shape offering the traditional timber appearance.

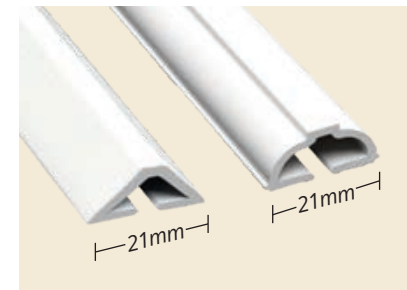

### 21mm ASTRAGAL BAR

Residence 9, Imagine and Flush 70.

21mm Astragal bar with square cut external bar to sash/frame giving a tidy appearance.

Available Double or Triple Glazed  
Optional for Kömmerring 70

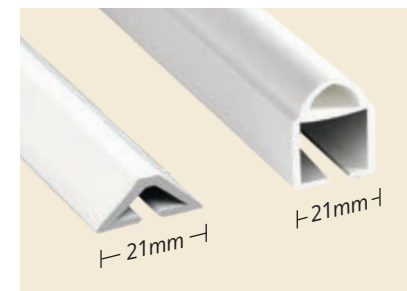

### 21mm ECLECTIC ASTRAGAL BAR

Available as optional (or if colour dictates) Astragal Bar for Residence 9

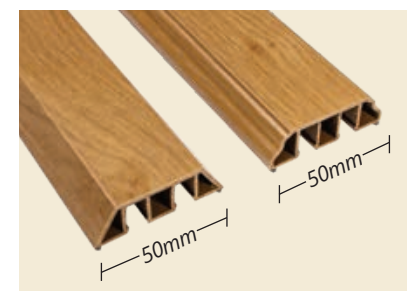

### 50mm ASTRAGAL BAR

Kömmerring 70 - Linear only

50mm wide clip fit linear astragal bar perfect for creating that cottage bar look or a mullion effect on doors

Can be used in conjunction with our 25mm Astragal Bar

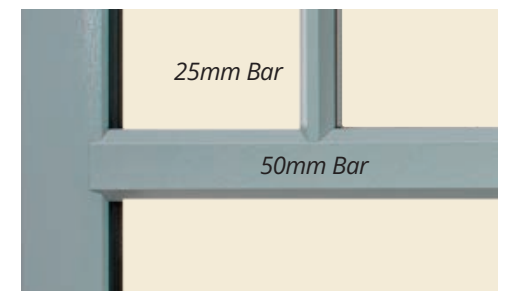

## Radlington Cill

The Radlington cill is a modern interpretation of a traditional timber cill. Available as 55mm x 165mm for all our 100mm and 70mm window and door systems.

For R7 and R9 a 30mm x 165mm Radlington cill is supplied as standard (55mm cill available as an option).

Optional internal trims available.



55mm deep Radlington cill





# Be Sure You're Secure, with Intelligent Security Alerts.

## Only from Kubu.

### Did you know over 90% of alarm triggers in the UK are false alarms<sup>†</sup>?

Alarm Blindness is setting in – people are more likely to think 'Shut up!' than wonder what's up...

Kubu offers a smarter, more personal solution – providing accurate, timely and meaningful alerts like never before.

It's an intelligent alerting system that integrates directly with your locks, giving real-time security updates, directly to your pocket.



<sup>†</sup> Source: Origin Wireless AI: False Alarms in Security Systems - 08/08/23

## Key Features

### SureShield™

Enhance your home security with real-time critical notifications that override 'Do Not Disturb' for any attack, tampering or security threats.

### Geofence Alerts

Never forget to secure your home again. Kubu will send you an alert if you've forgotten to lock up, before you get too far from home.

### Perimeter Security

Secure every opening around the entire perimeter of your property, with Kubu's range of smart security sensors.

### Family Sharing

Keep loved ones connected by letting them check your security status via the app, offering shared peace of mind wherever they are.

### Scheduled Alerts

Scheduled alerts make life easier—like a bedtime reminder of the status of your doors and windows, ensuring your home is secure while you rest peacefully.

### Smart Integration

Turn off the heating when you open a window; Ask Alexa if your home is secure; or even sound the alarm. Kubu integrates with most smart home devices.



## Intelligent Sensors

- Physical and technological security combined
- Detects a breach before it even happens
- Reports open, closed, locked AND vent modes
- Tamper protection built in
- Completely concealed
- Calibration FREE



## Intelligent Controls

- Fully *Smart Home* integrated
- Works with most major smart-tech brands
- Controlled with the Kubu® smart phone app
- Uses AI/machine learning
- Can activate automations by turning a key, or opening a window...



## Intelligent Alerts

- Instant, Personalised Security Updates
- SureShield™ Attack Alerts
- SureSecure™ Geofence Alerts
- Scheduled Notifications
- Family Sharing
- SmartAir™/Weather Alerts\*

\*coming soon

'Choices' in partnership with Kubu, ensures all Kömmerling windows and doors, "Alternative to Timber" doors and Solidor, work with Kubu as standard.



for all Kömmlering profiles see pages 4-9 See pages 32-33 See pages 36-37

## Award winning smart security:





Choice of PAS024,  
3★ security.

# ULTION | ★★★ STAYS LOCKED

Every body approves



British Standards  
TS007:2014 3 star



Police  
Preferred Specification



Did you know?	9 seconds are all it takes for a burglar to snap a standard lock & break in.	12pm - 4pm is roughly the time most burglaries take place.
76% of burglars go through a door, not the windows.	64% of burglaries happen when someone is at home.	30% see the intruder in the home.

When the Ultion lock detects an attack, it goes into

## Lock Down Mode™

A hidden attack lock secures the mechanism.



### New. Folding key available

Ideal for bi-folding doors. Its rubberised head houses a hinge mechanism so as not to damage the opposite door frame.



### New. Find your Ultion Key with Apple® Find My

Our Keytag™ uses Apple's Find My network to help locate a lost key. It can notify an iPhone, iPad or Mac if the key has been left behind and sounds an alarm when it's nearby.





# ‘Alternative to Timber’ Doors

Period style doors ideal for new and old properties, designed specifically with timber in mind.  
Standard door range below (French Door options available in all styles)



## Colour Options



## Glass Upgrades



Ask for our latest Glass Design brochure

# The ‘Alternative to Timber’ Doors Hardware

## Choices

The ‘Alternative To Timber’ door range is a traditional style door manufactured from Kömmerling O70 or C70 profiles with all the benefits of modern materials. Expertly hand crafted with mechanically jointed midrails and mullions to create an authentic wooden appearance.



See pages 28-29

## Standard Handles, Letterplates and Cylinder



Hardware Upgrades page 46

## Door Knockers



## Door Knocker Colours



## Sandblasted Numbers



## Low Threshold



## Fanlight



## ULTION 3 Cylinder Upgrade



## Sweet Range Hardware Upgrade

### Sweet Handles

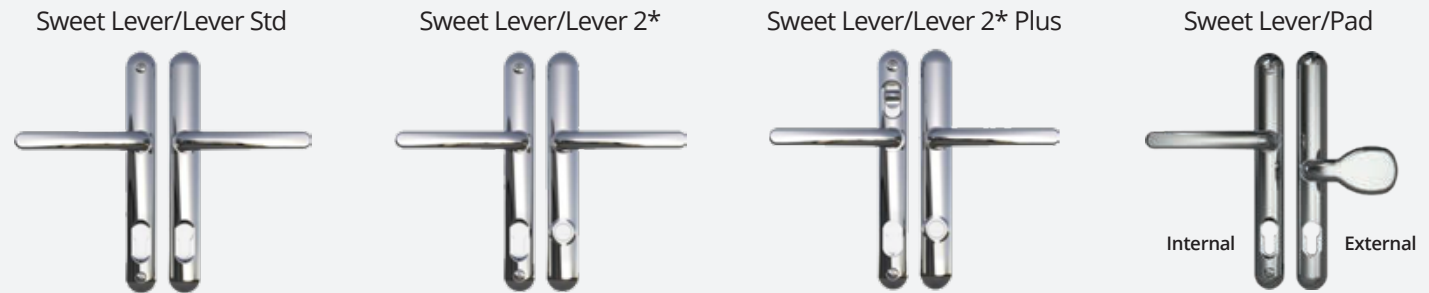

### Sweet Knockers



### Sweet Letterplates

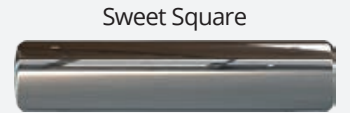

### Colours and Finishes

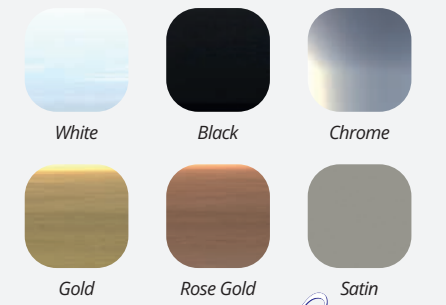



# Residor Collection

Choose between 16 door designs



Toton 1 Timperley 1 Timperley Fan 1 Timperley 3 Lytham 2 Toton 2



Chilwell 2 Turnberry 1 Chilwell 1 Newbridge 2 Newbridge 4 Gosforth 1



Gosforth Solid Monsall Solid Kendrick 3 Kendrick 4



Toplight option

# Residor Collection

## Choices

Residor are the most secure GRP composite doors on the market. With a wide range of colour and glass options available, each door range is fully customisable to you.

### All doors include

- ✓ Glazing cassettes
- ✓ Through colour weather bar
- ✓ Clear/obscure glazed units
- ✓ 70mm Veka outer frame
- ✓ ERA lock and keeps
- ✓ ULTION Three 35/35 cylinder
- ✓ Lever/Lever handles: White/Gold/Black/Chrome/Brushed Chrome
- ✓ White edge band only
- ✓ 1.4M/w2k 'U' Value

ULTION 3 Cylinder



### Extras and Accessories

- ✓ Letterplate, Urn knocker, Urn/Spyhole, Door viewer, Lever/Pad (Colours available as per Lever/Lever handles)
- ✓ Door guard
- ✓ Thumbturn
- ✓ Low ali threshold
- ✓ Additional 3 Keys
- ✓ Toplight
- ✓ Cills
- ✓ Wide range of glass designs

### For PAS 24 add

- ✓ 6.8mm laminate glass
- ✓ If letterplate is to be fitted it must be Trojan and Cowl TS008 must be fitted



Cowl TS008

1.4  
'U' Value



### Slab Colour Options

External colours always white internal

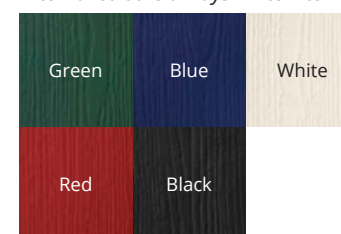

### Slab Colour Upgrade

External only

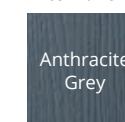

### Frame Colour

White both sides



### Frame Colour Upgrade

On white only

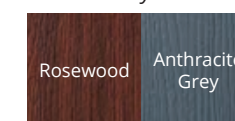

**The Gosforth 1, Gosforth Solid, Kendrick 3, Kendrick 4 and Turnberry 1**  
Minimum Width 820mm - Maximum Width 1023mm

**All other Doors**  
Minimum Width 850mm - Maximum Width 1023mm

**Frame Height** Minimum / Maximum

Std PVCU Threshold 2018mm to 2118mm

Mobility Threshold AM3 Deduct 33mm

Mobility Threshold AM5 Deduct 34mm (open out only)

**Part M Compliant over 945mm wide with mobility threshold**





# The Solidor Collection



# Solidor



## Choices

Solidor range of timber composite doors are widely admired for their stunning design, and unparalleled security.

- ✓ Available with optional side panels and even in a french door combination or both.
- ✓ Kubu prepared - Exclusive to CWG Choices
- ✓ SBD Available
- ✓ 1.4M/w2k 'U' Value

**works with Kubu®** Applies to Solidors supplied with Avantis locks.  
See pages 28-29

**Exclusively and standard to CWG Customers**

## Slab Colour Options

**Standard range slab colours**

Green	Blue	White
Ruby Red	Black	

**Premium range slab colours**

Golden Oak	Rosewood	Cream	Buttercup	Granite Grey
Foiled White	Anthracite Grey	Schwarzbraun (Black/Brown)	Pistachio	Pottery Blue
Forest Green	Truffle Brown	Pebble Grey		

**Luxury range slab colours**

Irish Oak	Chartwell Green	French Grey	Peacock Blue	Twilight Grey
Painswick	Duck Egg Blue	Tangerine	Midnight Grey	

## Frame Colour Options

Foiled both sides or foiled on white

Rosewood	Golden Oak	Black/Brown	Cream	Irish Oak	Anthracite Grey / White (O70 or C70)	Anthracite Grey (Both Sides C70 only)	White Ash (Both sides only)	Painswick Grey on White (C70 Only)	Chartwell Green on White Only
----------	------------	-------------	-------	-----------	--------------------------------------	---------------------------------------	-----------------------------	------------------------------------	-------------------------------

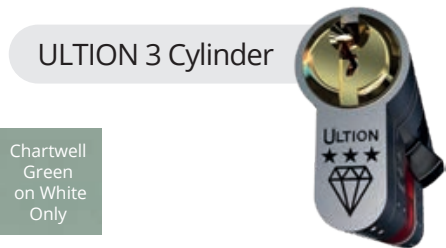

## Outer Frame Options

### Outer Frame Type

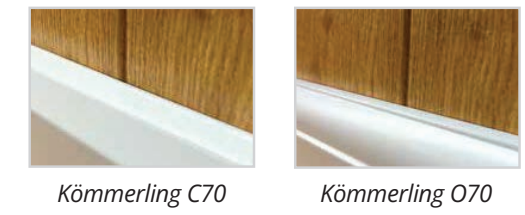

### Edgeband colours

White as standard, brown on rosewood or black foil both sides and caramel on golden oak or irish oak both sides.

White	Caramel	Brown
-------	---------	-------

### Hinge Clearance

Flag hinges provide 35mm clearance for open in doors (as illustrated).

Open out doors have butt hinges only.

## Solidor French and Stable Doors

### Solidor French Doors

Includes keyed alike ULTION PLUS thumbturn cylinders.

NB: Available with PVCU and Aluminium threshold on 'open in' doors. PVCU threshold only on 'open out' doors.

Please contact us for advice on minimum and maximum sizes.

### Solidor Stable Door

Includes keyed alike ULTION PLUS thumbturn cylinders.

Only the Flint range of Solidor are available as a stable doors. Available in any colour, on any side.

Only available as open inwards doors

**Door Minimum Width 843mm - Maximum Width 1013mm**  
The Italia range and Flint doors with single cassettes can be narrower

Frame Height	Minimum/Maximum
Std PVCU Threshold	1953mm to 2163mm
Low PVCU Threshold - C70	1939mm to 2149mm
Low PVCU Threshold - O70	1939mm to 2153mm
Mobility Threshold	1921mm to 2131mm

**Part M Compliant over 945mm wide with mobility threshold**

**Side Screen Minimum Width 403mm Maximum Width 563mm**

**Flint & Thornbury Side Panels available from: Min width - 350mm Max width - 1000mm**



# PremiLine

## Sliding Patio Door



### Choices

The 'Choices' PremiLine Sliding Patio door is available in 2, 3 or 4 pane configurations.

*Smooth sliding operation with stylish looks*

#### Standard Specification (includes glazing):

- ✓ 70mm profile depth with internally glazed sculptured beads
- ✓ Black gaskets with woolpile weatherseals
- ✓ White (chrome and gold effect - upgrades) handles
- ✓ Six point - six hook - locking
- ✓ Fully welded and reinforced
- ✓ Stainless steel adjustable rollers on a stainless steel track
- ✓ Slides on outer track as standard - inner track on request
- ✓ 28mm toughened sealed units with Low E Plus Argon gas and warm edge spacer
- ✓ PVCU profiles using 'greenline' 100% lead free stabilizer
- ✓ 20mm low aluminium threshold available (lower weather rating)
- ✓ Mechanically jointed outer frame available
- ✓ Sliding pane external as standard - can be specified to be internal
- ✓ 1.4W/m<sup>2</sup>K 'U' value with Low-E Plus glass
- ✓ 32mm triple glazing option
- ✓ Ultion One Cylinder



# PremiLine Sliding Patio Door

## PremiLine PRO PAS 24 Upgrade

'Lifetime Homes' and 'Document Q' compliant (2 and 3 pane doors only)

PAS 24 test data based on 2 pane patio door at 2450mm wide x 2260mm high

- A** Top rail 'dog bolt' keep
- B** Top rail 'dog bolt'
- C** 6.8mm laminate / argon / 4mm toughened
- D** Interlock handle - White, Black, Chrome
- E** Interlock hook bolts (x3)
- F** Interlock keeps (x3)
- G** Sash hook locks (x8)
- H** Sliding Sash Internal Only

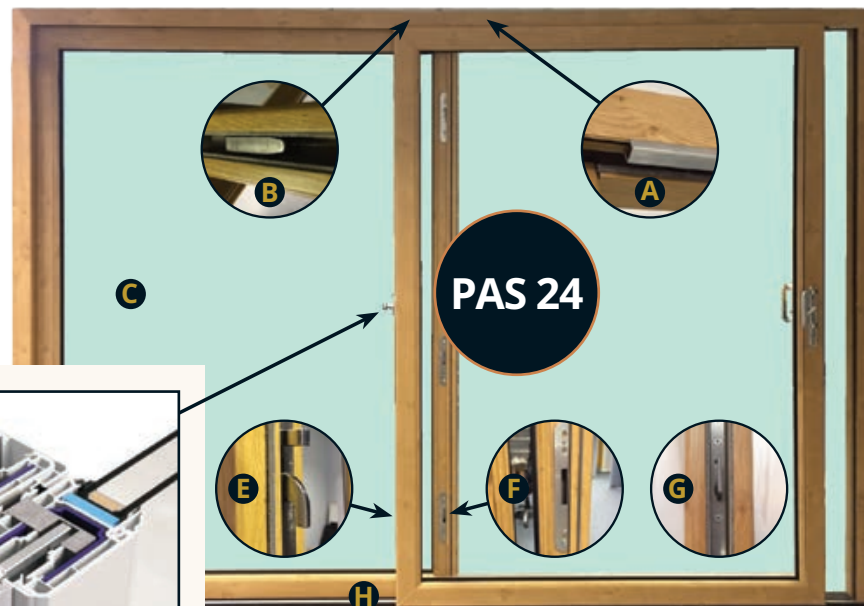

### PremiLine PRO

Innovative hidden locking system with interlock handle eliminates the need for unsightly plunge bolts.

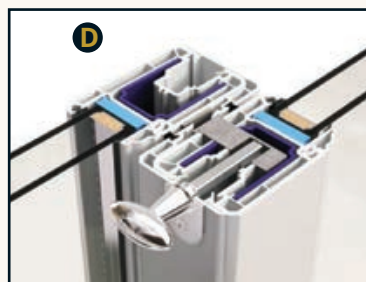

ULTION 1 PLUS

### Colour Options

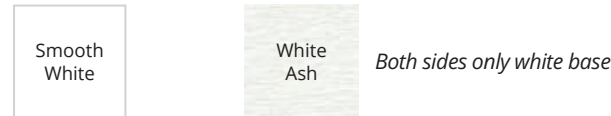

Available both sides or on smooth white

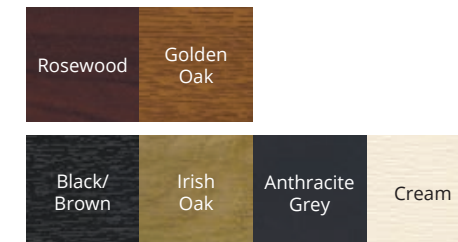

Available on smooth white only

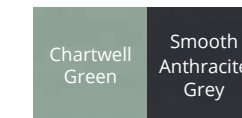

Available on smooth white only extra lead time



NB: Foiled on White profiles will show White on the insides of the head and base outer frame

Door Sizes - Maximum		
2 Pane 3000mm width x 2300mm height	3 Pane 4200mm width x 2300mm height	4 Pane 5800mm width x 2300mm height

NB: The height of the sash must not be more than 2.5 times larger than the width e.g. Frame height 2090mm means minimum frame width of 1600mm

### 20mm low aluminium threshold





# PVCU Bi-fold

*imagine*





## Choices

The 'Imagine' PVCU Bi-fold door combines the rigidity of aluminium and the aesthetics of timber with flush fitting sashes.

Its attention to detail in design, security and thermal performance all combine to make it a truly innovative way to transform any room.

### Standard Specification

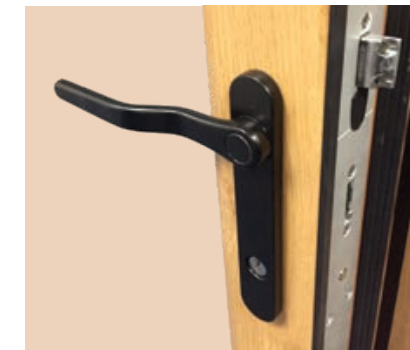
- ✓ Available opening inwards or outwards
- ✓ 6 chambered stepped 70mm outer frame
- ✓ 5 chambered 80mm sightline sash
- ✓ 28mm Planitherm toughened sealed units with Argon gas and black warm edge spacer
- ✓ Sculptured beads with black gaskets
- ✓ Hinges and D handle supplied in black (white available)
- ✓ Magnets when required will match hinge colour
- ✓ Fully welded outer frame (mechanical jointed option available)



*Cranked lever/lever handle available in White, Black, Gold and Chrome*

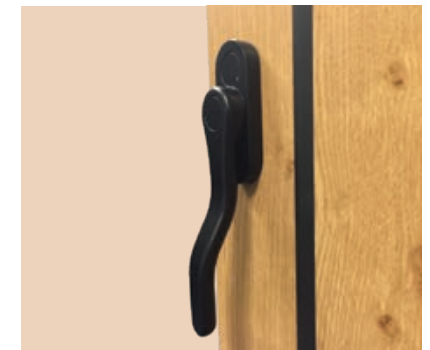

*Internal Intermediate handle available in White, Black, Gold and Chrome*



*Hidden track*



*Fully adjustable hinges available in White or Black*

A firm load bearing lintel is required to ensure a solid fixing to the head.

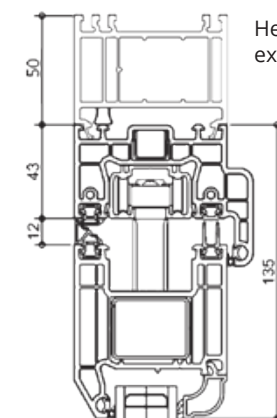

Head detail showing optional 50mm extender (suitable for trickle vents)

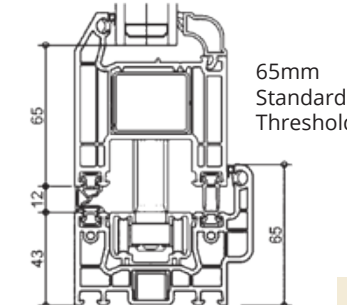

65mm Standard Threshold

### Threshold and Trickle Vent Options

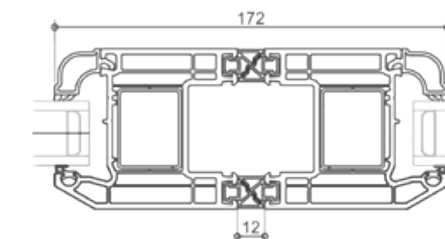

Glass to glass sightline of 172mm on all leaves



30mm low threshold\*\*



Room Divider  
15mm threshold for internal use only



Optional ramp for 30mm low threshold

\*\* If used externally draft proofing and weather performance will be reduced

# PVCU Bi-fold

### Features and Benefits

- ✓ Clean Contemporary look with slim sight-lines
- ✓ Outstanding thermal performance
- ✓ Available triple glazed
- ✓ 'U' value 1.4W/m<sup>2</sup>K double glazed
- ✓ 'U' value 1.2W/m<sup>2</sup>K with Low-E Plus glass
- ✓ 'U' value 1.0W/m<sup>2</sup>K triple glazed
- ✓ Fully adjustable slimline hinges
- ✓ Hidden track
- ✓ Choice of foil options
- ✓ Suited furniture
- ✓ Cranked lever/lever handle to allow tight stacking
- ✓ Premium quality magnets
- ✓ Available in 16 different opening configurations
- ✓ DDA compliant where required
- ✓ Fully welded or mechanical outer frame and sashes
- ✓ PAS 24 and Secure by Design achievable (Must have standard cranked handle)
- ✓ ERA 5 star guarantee
- ✓ Choice of 3 threshold options
- ✓ 20mm Astragal Bar option
- ✓ Midrail option available



Choices See more online visit [www.cwgchoices.com/imagine-bifold](http://www.cwgchoices.com/imagine-bifold)

Contact your local 'Choices' Installer for more information

Choices



# Imagine Bi-folding, Single and Double Doors

## Colour Options



# PVCU Doors

## imagine

## Choices

'Imagine' single or double doors are the ideal complement to any flush fitting window due to their flush fitting sashes.

To achieve the flush external match, the doors must open out. The double doors have no floating mullion and so offer slimmer sightlines.

### Specification:

- ✓ Available as open in or open out
- ✓ ULTION ONE Security Cylinder
- ✓ No floating mullion on French doors
- ✓ Fully adjustable slimline hinges
- ✓ Slim sightlines
- ✓ Equal sightlines
- ✓ Supplied with White or Black standard Lever/Lever handles
- ✓ 28mm Planitherm toughened sealed units with Argon gas and black warm edge spacer
- ✓ 'U' value 1.4W/m<sup>2</sup>K double glazed
- ✓ 'U' value 1.2W/m<sup>2</sup>K with Low-E Plus glass
- ✓ 'U' value 1.0W/m<sup>2</sup>K triple glazed
- ✓ Available triple glazed
- ✓ PAS 24 option available
- ✓ 30mm low threshold option



### Width Range (mm)

Min	Max	Configuration
710	1108	Fixed, Fixed/Dummy, Single Door
1370	2118	Double Door, T
1970	3128	T, L, T, L
2570	4138	T, T, T, T, L, L, T, T
3170	5148	T, T, L, T, T, L, T, T
3770	6000	T, T, L, L, T, T, T, T
4370	6000	T, T, T, L, T, T, T, L, T, T

## Imagine Door Configurations

Tested by Veka to maximum height for PAS 24

Std frame	2213mm
Std frame / Low Ali threshold	2200mm
Std frame / Room divider	2172mm

### Key:

⚠ These doors do not have a single prime door. Two leaves need to be operated together - No external handle available

▬ Sashes are manufactured 60mm wider than adjoining sashes to allow them to operate correctly

L Indicates cranked lever/lever handle with euro cylinder

T Indicates internal intermediate handle

M Indicates magnet



Traditional handles Upgrade



Cranked handle (Obligatory for SBD)



20mm Astragal bar



Colour matched rebate adapter

## Imagine Door Range Handles

### Standard Bi-fold Handles



Cranked (Main door handle)  
Intermediate  
(Black, White, Gold, Chrome)

### Handle Range for Imagine Single and Double doors

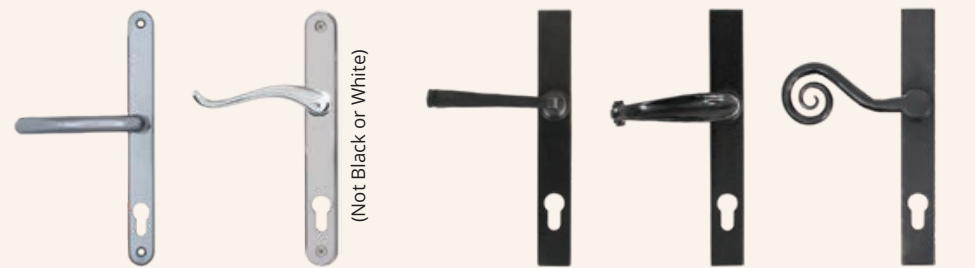

Balmoral Black, White, Hardex Gold, Hardex Satin, Hardex Bright Chrome, Hardex Graphite or Antique Black

Swan (Not Black or White)

Noble Black or Pewter

Sculptured Black or Pewter

Monkey Tail Black or Pewter



Lever/Lever Handles



Slimline Hinges



115 mm midrail upgrade



Mechanical joint upgrade



Single door with midrail and Astragal Bars



Modern design single door with tongue and groove panel

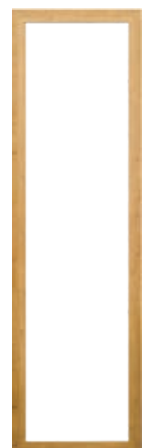

Side screen no dummy sash



Side screen dummy sash



1.2  
Double  
Glazed



THE RESIDENCE COLLECTION

# Doors



## Choices

Timberwelded open out single and double doors offer a suited solution to match the Residence R7, R9 and R2 window collection.

- Timberwelded frame and sash as standard
- PAS 24\* and SBD\* upgrade option

### Open In Doors

R7 & R9 Open In doors limited colour range - see pages 14 & 16

Upgrade to traditional Handles  
Available in Pewter or Black

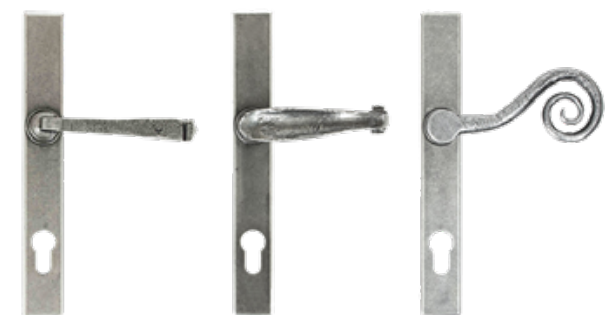

Noble      Sculptured      Monkey Tail



\*Pending due early 2025

# Residence Collection Doors

Looks Like Timber - Feels Like Timber



2 reverse claws



Lever/Lever handles



3D Adjustable Hinge



ULTION 1 PLUS



Top and bottom shoot bolts to both leaves



Decorative Astragal bars upgrade

COLOUR OPTIONS  
SEE PAGES  
14, 16 & 18







'Choices' doors have a high security specification as standard

### Standard Specification:

- A** ULTION 1 PLUS
- B** Kubu ready\*
- C** 25mm throw direct drive centre compression deadbolt provides high level of security in the centre of door
- D** Adjustable Dynamic hinge
- E** Fully adjustable security keeps
- F** Hook claws top and bottom operate in reverse directions for anti-lift
- G** Shoot bolt bullet point



See pages 28-29

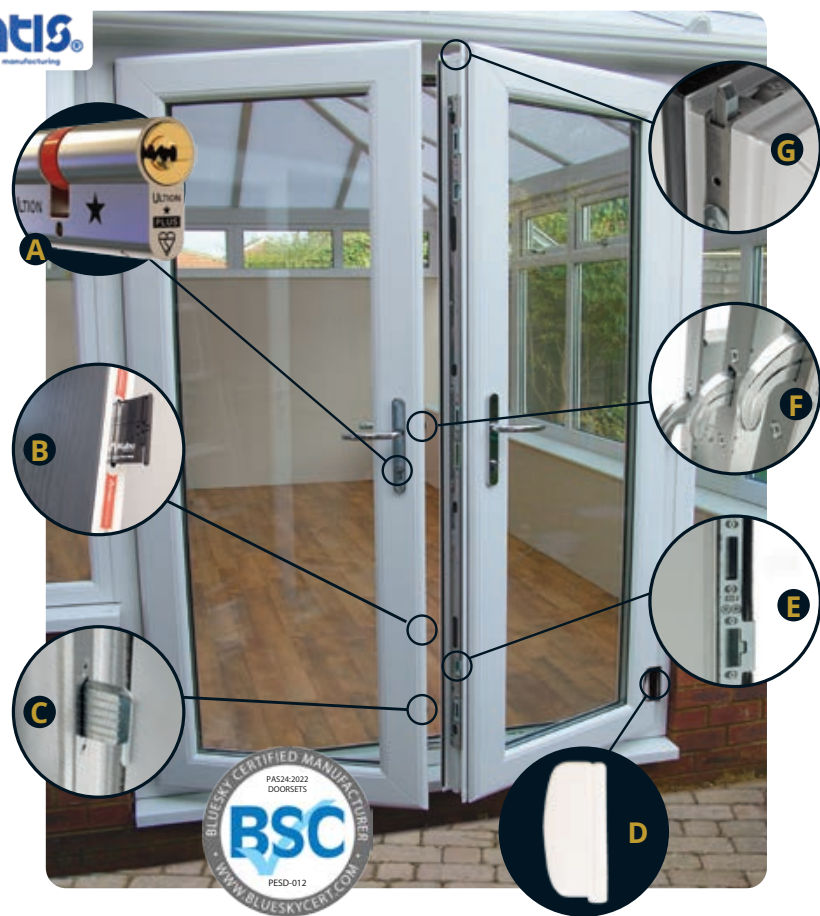

\*Kubu smart kit purchase required by home owner

### Secured by Design

6.8mm laminate glazing and ULTION 3 Cylinder upgrade required.



### ULTION 3 Cylinder upgrade



#### Features and Benefits

- ✓ Eleven Pin Locking
- ✓ 294,970 Lock Combinations
- ✓ 100,000 Cycle Endurance Test
- ✓ Snap Tested Resistant Sections
- ✓ Drilling, Pick and Bump Tested
- ✓ Molybdenum Alloy Core
- ✓ Available on any new 'Choices' door
- ✓ All Locks can have the same key
- ✓ Single, Double, Sliding and Bi Folding
- ✓ Retro Fit into existing doors

Ultion Plus cylinders are available to fit to any new 'Choices' single, double or bi-fold door and can be retrofitted to existing 'Choices' doors

The basis of the high security is the Molybdenum Alloy Core (Centre section) which as soon as the lock comes under attack, goes into 'Lockdown Mode'. The first two sections are designed to 'snap' off - then the attacker will be confronted with the high security 'core'.

Please note Ultion Plus cylinders are only supplied with 3 keys per set, so additional keys may be required when ordering keyed alike cylinders as part of a set

### Panic Bars to BS:EN 14351 upgrade

Multi-point panic bar door lock with optional external access suitable for Single or Double doors. Double doors can be supplied offset to give maximum width for Master door.

PVCU doors are not recommended for high commercial usage

**External access option requires key for entry from outside**

Double doors supplied with panic bar to master door only, slave leaf operated by GZR finger operated bolt



### Standard Door Handle Range



Balmoral Handles

Available in all colours shown in the Letterbox Range below

### Traditional Door Handle Range

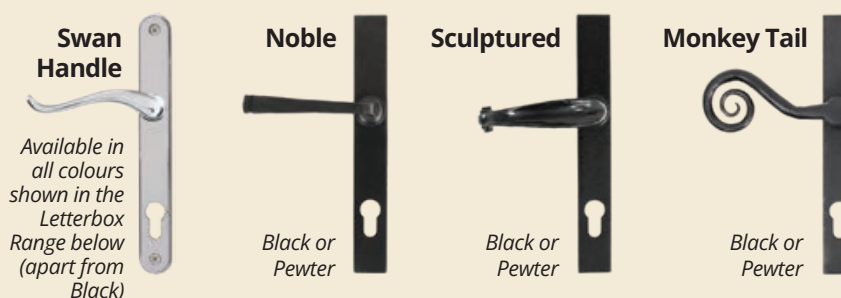

Available in all colours shown in the Letterbox Range below (apart from Black)

### Standard Letterbox Range



### Premium Letterbox Range

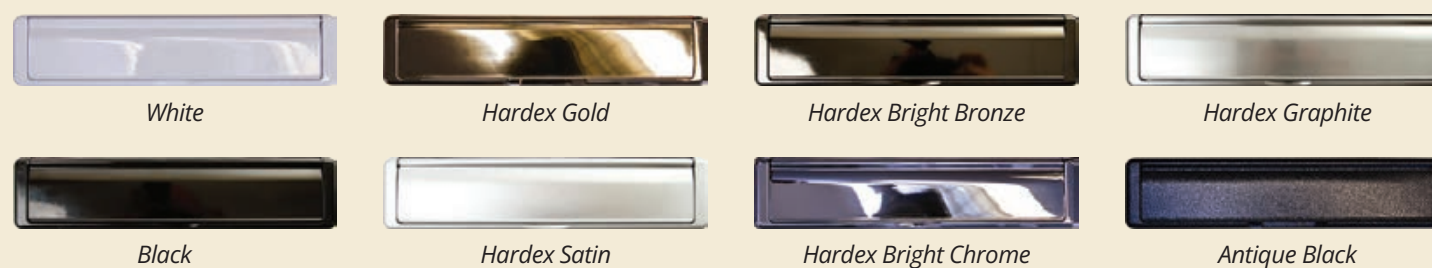

### Dynamic door hinge



### Mobility Threshold

Part M thermally broken mobility threshold available in anodised silver or gold with optional access wheel chair ramps

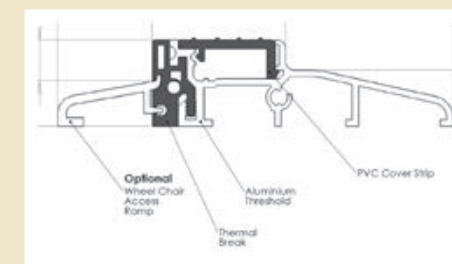



# 'Choices' Aluminium Windows

SIMPLE • SUSTAINABLE • COMPLIANT

Choices

ALUK®

# Aluminium WINDOWS

NEW for 2025  
ALUK 58BW HI Windows



SUSTAINABLY SOURCED  
78% RECYCLED  
ALUMINIUM BILLET CONTENT



1.4  
Double Glazed  
1.2  
Triple Glazed

ENERGY EFFICIENT  
PART L  
COMPLIANT  
FOR A GREENER HOME



## Key Features

- ✓ Built to the highest UK standards, this effective and high performance solution offers clean lines and advanced functionality
- ✓ U-value compliant of 1.4W/m²k (Refurbishment) 24mm double glazed unit (DGU)
- ✓ U-value compliant of 1.2W/m²k (New Build) 32mm triple glazed unit (TGU)
- ✓ PAS24 (2022) & SBD Certified if requested
- ✓ Available in a wide range of styles and formats including flush sash
- ✓ Black or White cranked handles
- ✓ Using the same frame profiles as the 58BD Door
- ✓ Available as a Contemporary Flat Sash, Commercial and Flush Sash Window option
- ✓ Deep leg frame which suites with the standard frame allows trickle vents to be added without additional profiles
- ✓ Sustainably sourced; 78% recycled content of the aluminium billet

## SPECIFICATIONS

Performance and accreditations	58BW CASEMENT HI
U-Value (Double Glazing)	1.4 W/m²k
U-Value (Triple Glazing)	1.2 W/m²k
BRE Green Guide Rating	A rated
Air Permeability	Class 4 (600 Pa)
Water Tightness	Class 9a (600 Pa)
Wind Resistance	Class E2400 (2400 Pa)
Security	PAS 24 & SBD When specified

## Upgrades/Options

- Frame Depths - 58mm or 70mm (Flush Sash 70mm only)
- Frame Heights - 43mm or 53mm (Flush Sash 53mm only)
- Security Compliance - PAS 24 / Doc Q / SBD
- WER A - with Low Iron Glass and 43mm frame height
- Handles - Colour options, Monkey tail or Pear drop (see pages 24-25)
- Other Colours - Full range of RAL colours in single or dual finishes

## Contemporary Flat Sash

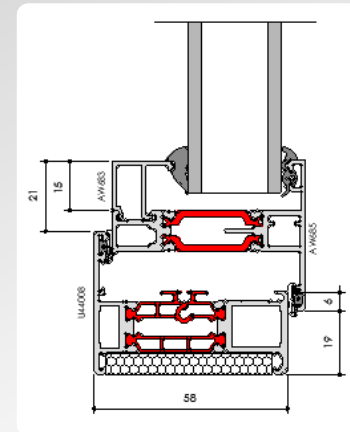

## Contemporary Flat Sash in 70mm frame

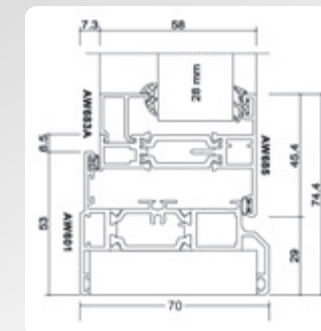

## Flush Sash

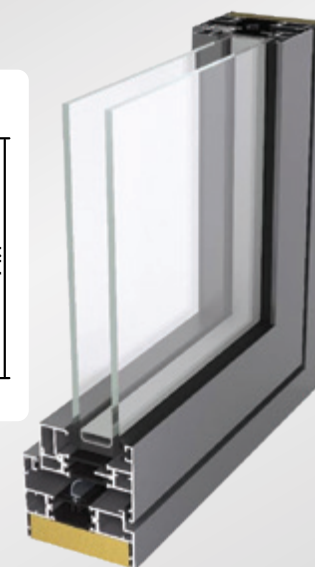
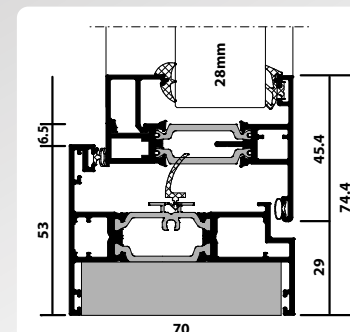

## Commercial Sash

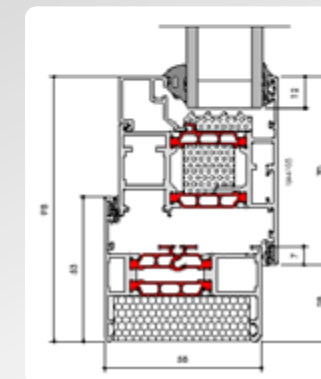

## Colour Options

for fast delivery

White RAL 9910hg	Black RAL 9005m	Anthracite Grey RAL 7016m	Anthracite Grey	Black
			White	White



SIMPLE • SUSTAINABLE • COMPLIANT

**ALUK**

**Aluminium  
HERITAGE**

*Choices*

**NEW for 2025**

**Heritage 58BD ST HI Doors**

**SUSTAINABLY SOURCED  
78% RECYCLED  
ALUMINIUM BILLET CONTENT**



## Heritage 58BW ST HI Windows

### Key Features

- ✓ Designed to offer a modern aluminium replacement to traditional steel windows and doors.
- ✓ A high performance update to a heritage design classic.
- ✓ Window & Door U-value compliant of 1.4W/m<sup>2</sup>k (Refurbishment) 24mm double glazed unit (DGU)
- ✓ Window U-value compliant of 1.2W/m<sup>2</sup>k (New Build) 32mm triple glazed unit (TGU)
- ✓ Door U-value compliant of 1.3W/m<sup>2</sup>k with 32mm triple glazed unit (TGU)
- ✓ Using the same frame & ancillary profiles as the 58BW HI & 58BD HI Door
- ✓ Deep leg frame which suites with the standard frame allows trickle vents to be added without additional profiles
- ✓ PAS24 (2022) & SBD Certified if requested for windows
- ✓ Sustainably sourced; 78% recycled content of the aluminium billet



**SUSTAINABLY SOURCED  
78% RECYCLED  
ALUMINIUM BILLET CONTENT**



### HERITAGE WINDOW SPECIFICATIONS

Performance and accreditations	58BW ST HI
U-Value (Double Glazing) (Ug:1.0W/M <sup>2</sup> K)	1.4W/m <sup>2</sup> k
U-Value (Triple Glazing) (Ug:0.8W/M <sup>2</sup> K)	1.2W/m <sup>2</sup> k
Window Energy Rating	A - B
BRE Green Guide Rating	A rated
Air Permeability	Class 4 (600 Pa)
Water Tightness	Class E1500 (1500 Pa)
Wind Resistance	Class E2400 (2400 Pa)
Security	PAS 24 & SBD When Specified
System	58BW ST HI
Depth	58mm & 70mm
Configurations	58BW ST HI
Opening	Open-Out
Top Hung	✓
Side Hung	✓
Bottom Hung	✓
Fixed Light	✓
Multi Light	✓

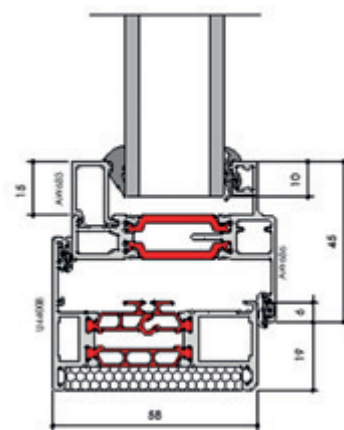

### Colour Options

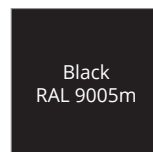

### HERITAGE DOOR SPECIFICATIONS

Performance and accreditations	Single Open Out	Double Open In
U-Value (Double Glazing 1.0 CP Unit)	1.4W/m <sup>2</sup> k	1.4W/m <sup>2</sup> k
Air Permeability	600 Pa (Class 4)*	600 Pa (Class 4)*
Water Tightness	750 Pa (Class E750)*	200 Pa (Class 5A)*
System		
Depth	58mm & 70mm	58mm & 70mm
Size and weight limits		
Max Door Size (WxH)	1000mm x 2300mm	2000mm x 2300mm
Min Door Size (WxH)	600mm x 1800mm	1200mm x 1800mm
Max Vent Weight	65kg	65kg
Glazing		
Glazing Thickness	24mm	24mm
Glazing Options	Double Glazed	Double Glazed
System Features		
Dual Colour Option	✓	✓
Multi-Point Locking	✓	✓
Barrell Hinges	✓	✓
Thermally Broken	Low Lambda PA	Low Lambda



Note: Slave sash operates on finger operated shoot-bolts

### Colour Options

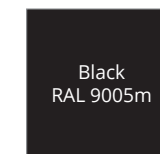

Side Light and Fan Light combinations available

**ULTRA  
SLIM  
Sightlines**

### Upgrades/Options

Frame Depths - 58mm or 70mm

Frame Heights - 43mm (only available in 58mm depth) or 53mm

Window Security Compliance - PAS 24 / Doc Q / SBD

Handles - Colour options, Monkey tail or Pear drop (see pages 24-25)

Colours Windows: Black (9005M), also available in White (9910HG), Anthracite Grey (7016M), Grey/White, Black/White - Fast delivery!

Colours Doors: Black (9005M) - Fast delivery!

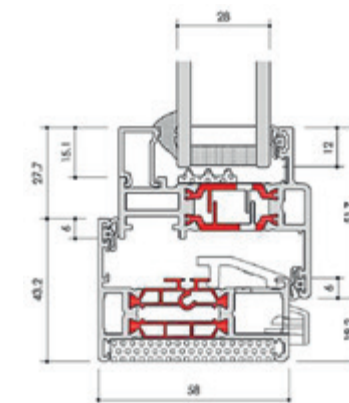



# Aluminium Doors

## ALUK 58BD HI Door System

Colour Options *for fast delivery*



SIMPLE • SUSTAINABLE • COMPLIANT

# ALUK Aluminium DOORS

*Choices*

**NEW for 2025**

## ALUK 58BD HI Door System

### Key Features

- ✓ Designed with security and flexibility front of mind, every door in the 58BD HI range is available in single and double configurations making them ideal for almost any application.
- ✓ Suitable for both new build and refurbishment projects
- ✓ U-value compliant of 1.4W/m<sup>2</sup>k (Refurbishment) 28mm double glazed unit (DGU)
- ✓ QuiK-Clip 28mm Bead for ease of glazing installation
- ✓ U-value compliant of 1.2W/m<sup>2</sup>k (New Build) 32mm triple glazed unit (TGU)
- ✓ U-value of 1.0W/m<sup>2</sup>k using a 40mm triple glazed unit (TGU)
- ✓ Available in a wide range of styles and formats (Single Door, French Door Side Lights, Top Lights, Open In, Open Out)
- ✓ Using the same frame and range of ancillary profiles as the 58BW HI & 58BW HI ST window
- ✓ Deep leg frame which suites with the standard frame allows trickle vents to be added without additional profiles
- ✓ PAS24 (2022) & SBD Certified if requested
- ✓ Sustainably sourced; 78% recycled content of the aluminium billet



### 58BD HI DOOR SYSTEM

Performance* and accreditations	Single Open-In	Single Open-Out	Double Open-In	Double Open-Out
U-Value (Double Glazing) (Ug: 1.1W/m <sup>2</sup> k)	1.4W/m <sup>2</sup> k	1.4W/m <sup>2</sup> k	1.4W/m <sup>2</sup> k	1.4W/m <sup>2</sup> k
U-Value (Triple Glazing) (Ug: 0.7W/m <sup>2</sup> k)	1.0W/m <sup>2</sup> k	1.0W/m <sup>2</sup> k	1.0W/m <sup>2</sup> k	1.0W/m <sup>2</sup> k
Air Permeability	Class 4 (600 Pa)	Class 4 (600 Pa)	Class 3 (600 Pa)	Class 3 (600 Pa)
Water Tightness	Class 3a (100 Pa)	Class 7a (300 Pa)	Class 7a (300 Pa)	Class 3a (600 Pa)
Wind Resistance	Class A3 (1200 Pa)	Class A3E2400 (2400 Pa)	Class A3 (1200 Pa)	Class A4 (1600 Pa)
Building Regulations Part L Compliant	✓	✓	✓	✓
Building Regulations Part M Compliant	✓	✓	✓	✓
Security	PAS 24 & SBD when specified	PAS 24 & SBD when specified	PAS 24 & SBD when specified	PAS 24 & SBD when specified
Durability EN1191 Category	50,000 Cycles	50,000 Cycles	50,000 Cycles	50,000 Cycles
<b>System</b>				
Depth	58mm - 70mm	58mm - 70mm	58mm - 70mm	58mm - 70mm
<b>Size and weight limits</b>				
Maximum Door Size (mm)	1200w x 2400h	1200w x 2400h	2400w x 2400h	2400w x 2400h
Maximum Door Weight	3 Hinges 67.5kg 4 Hinges 90kg	3 Hinges 67.5kg 4 Hinges 90kg	3 Hinges 67.5kg 4 Hinges 90kg	3 Hinges 67.5kg 4 Hinges 90kg
<b>Glazing</b>				
Glazing Thickness	24mm - 40mm	24mm - 40mm	24mm - 40mm	24mm - 40mm
<b>System Features</b>				
Single Colour	✓	✓	✓	✓
Dual Colour	✓	✓	✓	✓
Thermally Broken	✓	✓	✓	✓
Sightline (Head)	129.5mm	129.5mm	129.5mm	129.5mm
Low Threshold Sightline (Cill)	11mm	11mm	11mm	11mm
Sightline (Jamb)	129.5mm	129.5mm	129.5mm	129.5mm
Sightline (Meeting Stile)	n/a	n/a	209.5	209.5
Panel Door	✓	✓	✓	✓
Multi-Point Locking	✓	✓	✓	✓
Barrel Hinges	✓	✓	✓	✓
Low Threshold	✓	✓	✓	✓

### Upgrades/Options

- Frame Depths - 58mm or 70mm
- Frame Heights - 43mm or 53mm
- Door Security Compliance - PAS 24 / Doc Q / SBD
- Handles - Colour options, Traditional door handles (see page 47)

#### Std Threshold

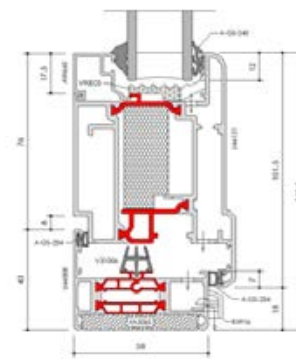

#### Low Threshold

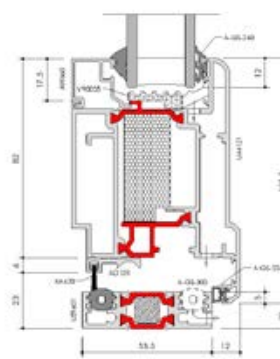

#### Single Door

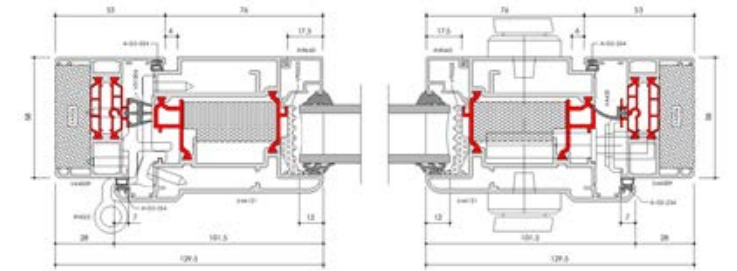

#### French Door Mullion

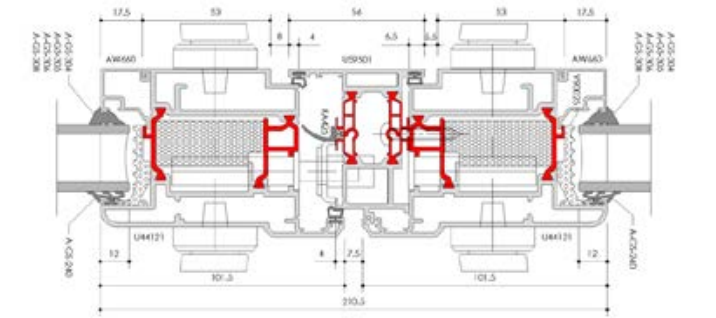



# Aluminium In-line Sliding Doors

SIMPLE • SUSTAINABLE • COMPLIANT

## ALUK S67 Slim In-Line Sliding Door

Colour Options *for fast delivery*

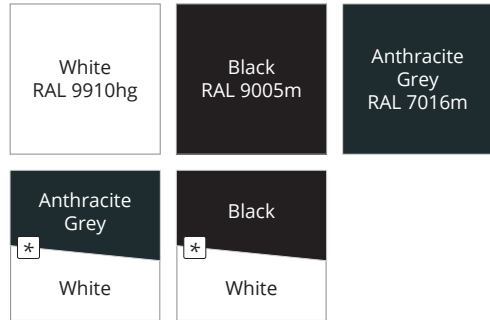

\* Not Triple Track or Low Threshold options



### S67 SLIM IN-LINE SLIDING DOOR

Performance and accreditations	S67
U-Value (Double Glazing) (Ug: 1.0W/m <sup>2</sup> k)	1.4W/m <sup>2</sup> k
Air Permeability	Class A4
Water Tightness	Class 9A
Wind Resistance	Class B3
Acoustic	30 - 40 dB
System	
Depth	67mm (Twin Rail) 130mm (Triple Rail)
Size and weight limits	
Maximum Leaf Height	2700mm
Maximum Leaf Width	3000mm
Maximum Leaf Weight	200kg
Glazing	
Glazing Thickness	24mm - 32mm



Handle Colours  
White, Black, Grey

### Configurations

#### DOUBLE TRACK

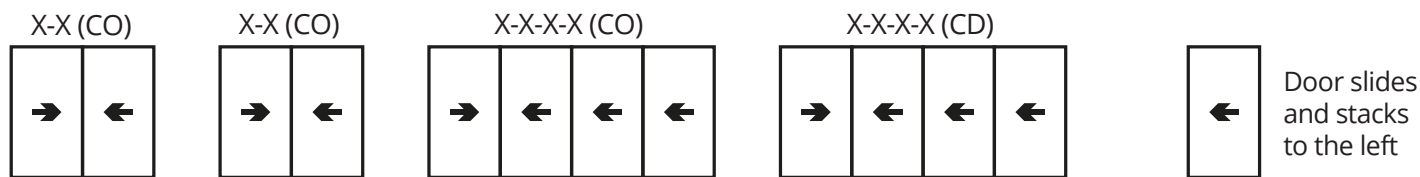

#### TRIPLE TRACK

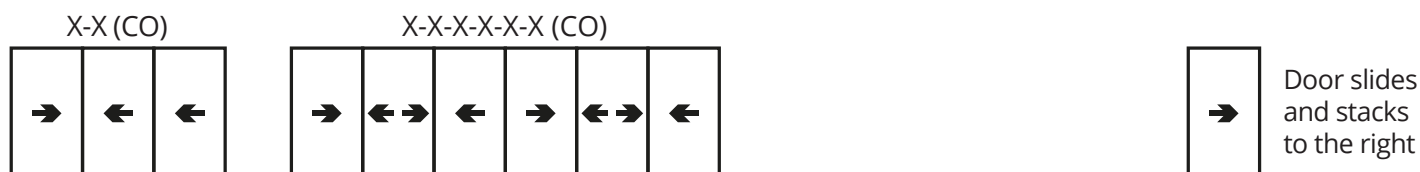

Choices

NEW for 2025

## ALUK S67 Slim In-Line Sliding Door

### Key Features

- ✓ S67 is a modern, versatile solution that blends contemporary design with impressive thermal performance
- ✓ Ultra slim 35mm interlock (standard and reinforced options)
- ✓ Low 22mm threshold optional
- ✓ Multipoint locking system
- ✓ Adjustable rollers (0 to + 4 mm)
- ✓ Maximum weight per sash of 50kg or 2.4m<sup>2</sup> (200kg with customer collection via 'Hiab')
- ✓ 2.4m x 2.4m door size 2-pane (Guidance)
- ✓ 3.6m x 2.4m door size 3-pane (Guidance)
- ✓ 4.8m x 2.4m door size 4 pane (Guidance)
- ✓ Min sash sizes 730mm x 450mm
- ✓ Available in double and triple track configurations
- ✓ U-value compliant of 1.4W/m<sup>2</sup>k (Refurbishment) 24mm double glazed unit (DGU)
- ✓ U-value compliant of 1.3/1.4W/m<sup>2</sup>k 32mm triple glazed unit (TGU)
- ✓ Ex-stock colours: White (9910HG), Anthracite Grey (7016M), Black (9005M), Grey/White, Black/White- Fast delivery in 2-3 weeks
- ✓ The pre glazed sash with adjustable rollers also offers a fast installation

ALUK®

# Aluminium In-Line Sliding Doors

SUSTAINABLY SOURCED  
78% RECYCLED  
ALUMINIUM BILLET CONTENT

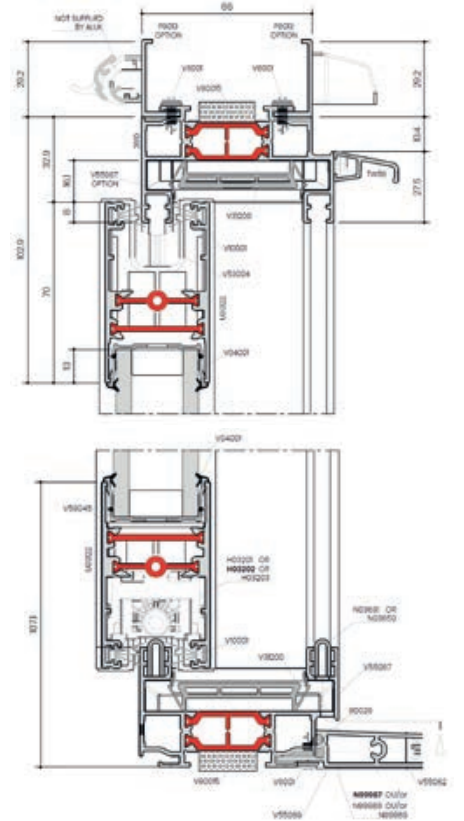



# Aluminium Lift & Slide Doors

SIMPLE • SUSTAINABLE • COMPLIANT

## ALUK S140 Lift & Slide Door

Colour Options *for fast delivery*

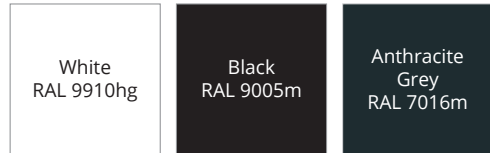

### S140 LIFT & SLIDE DOOR

Performance and accreditations	S140
U-Value Double Track 2500x2725mm (Double Glazing) 1.0 Ug	1.3W/m <sup>2</sup> k
U-Value Double Track 2500x2725mm (Triple Glazing) 0.6 Ug	1.0W/m <sup>2</sup> k
Air Permeability	Class 4 (600 Pa)
Water Tightness	Class 8A (450 Pa)
Wind Resistance	Class 4C (1600 Pa)
<b>System</b>	
Depth	140mm (Twin Rail) / 217.5mm (Triple Rail)
<b>Size and weight limits</b>	
Maximum Outer Frame W X H: Double Track	4982mm x 3100mm
Maximum Outer Frame W X H: Triple Track	6400mm x 3100mm
Maximum Leaf W X H: Double Track	2500mm x 3029mm
Maximum Leaf W X H: Triple Track	2190mm x 3029mm
Maximum Leaf Weight	420kg
<b>Glazing</b>	
Glazing Thickness	24mm - 40mm

Choices

NEW for 2025

## ALUK S140 Lift & Slide Door

### Key Features

- ✓ S140 offers slim sightlines with impressive strength and performance, making it suitable for almost any project
- ✓ Lift & Slide for ease of use and smooth function
- ✓ Slim interlock option of 44mm face width
- ✓ Accepts 24mm - 48mm glazing
- ✓ Max 420kg panel weight for larger projects \*unglazed
- ✓ QuiK Clip® - Clip in bead technology for faster glazing (coming soon)
- ✓ Dedicated sub cill
- ✓ Available in double and triple track configurations
- ✓ Ex-stock colours: White (9910HG), Anthracite Grey (7016M), Black (9005M), Grey/White, Black/White - Fast delivery
- ✓ 2-Pane Door U-value compliant of 1.3W/m<sup>2</sup>k (Refurbishment) 24mm double glazed unit (DGU)
- ✓ 3-Pane Door U-value compliant of 1.4W/m<sup>2</sup>k (Refurbishment) 24mm double glazed unit (DGU)
- ✓ 2-Pane Door U-value compliant of 1.0W/m<sup>2</sup>k (New Build) 40mm double glazed unit (DGU)
- ✓ 3-Pane Door U-value compliant of 1.1W/m<sup>2</sup>k (New Build) 40mm double glazed unit (DGU)
- ✓ Min sash size 730mm x 1370mm
- ✓ Sustainably sourced; 78% recycled content of the aluminium billet



### Configurations

#### DOUBLE TRACK

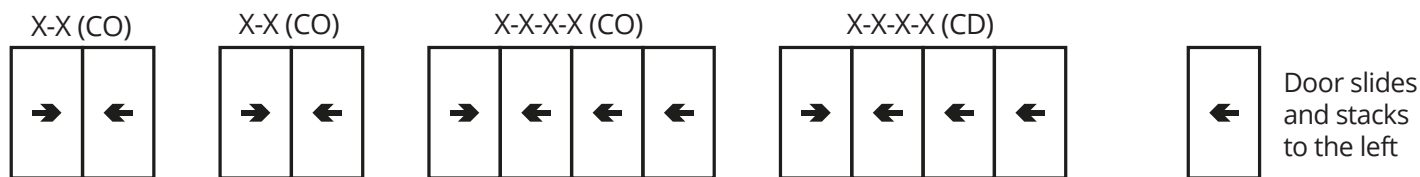

#### TRIPLE TRACK

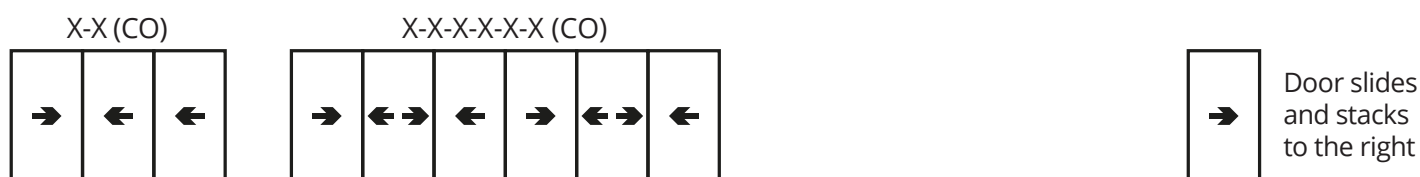





# ALUK<sup>®</sup> Aluminium BSF70 Bi-fold

## Choices

An intelligent combination of form and function, our highly versatile and market leading Bi-fold door systems gives you maximum control over the style and operations of the doors

## The *Standard* 'Choices' aluminium Bi-fold door is the Optio BSF70 Hi

### Design Features

- ✓ Internally beaded with a softline sash
- ✓ Stainless Steel Wheels
- ✓ Unique flush line pop up handle
- ✓ Magnetic catch for prime/slave leaf
- ✓ All configurations open in and open out
- ✓ Thermally broken aluminium sections
- ✓ 28mm sealed unit
- ✓ Black or White lever/lever prime handles
- ✓ Black or White internal pop-out handles
- ✓ 'U' value 1.4W/m<sup>2</sup>K
- ✓ QuiK-Clip 28mm Bead for ease of glazing installation

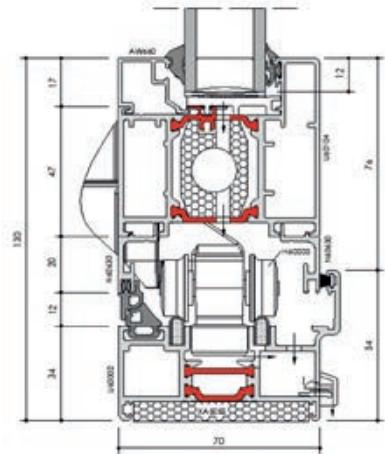
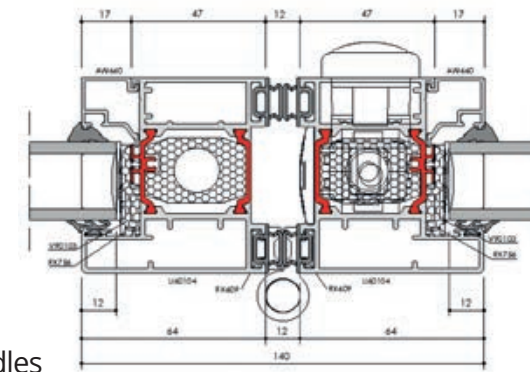

## Configurations

Available in a range of styles and designs, panels can be stacked inside or outside of the room, to the left, right or split to stack on both sides. Door sets can be manufactured to replace entire walls to maximise your opening space.

Type 1



Type 2

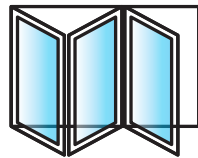

Type 3

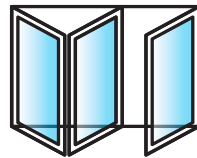

Type 4

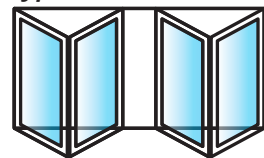

Type 5

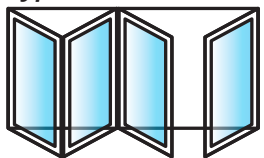

Type 6

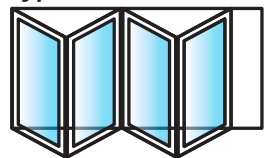

Type 7

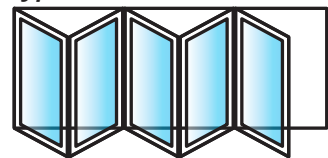

Type 8

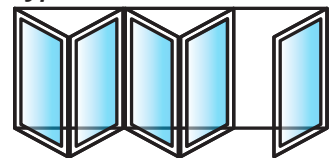

Type 9

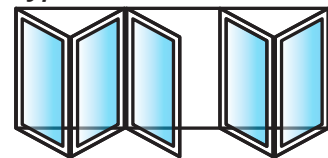

Type 10

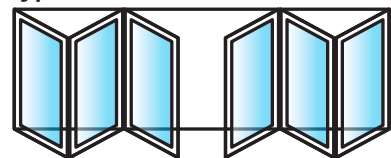

Type 12

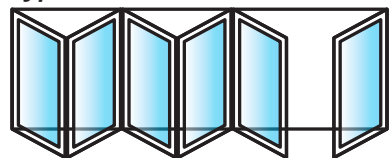

Type 13

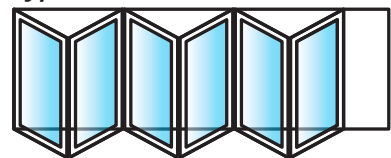

Minimum height 1950mm  
Minimum width 1400mm  
Minimum sash width 600mm

Maximum height 2400mm  
Maximum width 6300mm  
Maximum sash width 1200mm

All configurations have lever/lever handles on the prime leaf with the exception of types 1, 4, 6 and 13 which are internal handles only.



View QuikClip video online  
[www.cwgchoices.com/quikclip](http://www.cwgchoices.com/quikclip)

## Colour Options *for fast delivery*

White RAL 9910hg	Black RAL 9005m	Anthracite Grey RAL 7016m
Black	Anthracite Grey	White
White	White	

## Upgrades/Options

- ✓ Low threshold (no weather rating)
- ✓ A range of RAL single or dual colour
- ✓ PAS 24 / Doc Q / SBD
- ✓ Mechanically jointed outer frame
- ✓ 'U' Value 1.1W/m<sup>2</sup>K with Triple Glazed Low-E Plus
- ✓ Brushed chrome prime handles
- ✓ Intermediate Lever handle as an alternative to the Pop-out T handle. Colours: Black, White, Silver, Grey RAL7016, Chrome



Flush line pop-out handle



Intermediate lever handle option



Stainless steel wheels



Floating corner post option





SIMPLE • SUSTAINABLE • COMPLIANT

Choices

ALUK®

Aluminium  
COMMERCIAL

NEW for 2025

## GT55 TB Commercial Door System



## ALUK GT55 TB Commercial Door System

### Key Features

- ✓ High traffic pedestrian entrance door system for commercial and multi-occupancy residential applications.
- ✓ Part M and DDA Compliance - the GT55 TB includes ramped single and double door threshold options that also meet DDA standards
- ✓ U-value compliant of 1.4W/m²k 26mm double glazed unit (DGU) - Screens
- ✓ U-value compliant of 1.7W/m²k 24mm double glazed unit (DGU) - Single Door
- ✓ U-value compliant of 1.5W/m²k 40mm triple glazed unit (TGU) - Single Door
- ✓ U-value compliant of 1.8W/m²k 24mm double glazed unit (DGU) - Double Door
- ✓ U-value compliant of 1.6W/m²k 40mm triple glazed unit (TGU) - Double Door
- ✓ GT55 NI has been specifically designed for high traffic environments where no insulation is required. A robust and cost-effective choice when specifying applications such as shopping complexes and retail centres that require significant partitioning without the need for thermal insulation.
- ✓ Ex-stock colours White (9910HG), Anthracite Grey (7016M), - Fast delivery
- ✓ PAS24 (2022) & SBD (SBD pending) Certified if requested
- ✓ Pocket or bead glazed for ease of site glazing
- ✓ Ladder frame construction to enable fast on-site installation
- ✓ Sustainably sourced; 78% recycled content of the aluminium billet



### Upgrades/Options

Frame Depths - 58mm or 70mm

Frame Heights - 43mm or 53mm

#### Door Security Compliance -

PAS 24 Options on Single and Double Doors for Single point, Multi-point, Electronic access control, and Panic escape solutions.

Concealed closer mounted in header bar profile with adjustable operating forces with option to include Dorma RTS87 closer for DDA compliance relating to operating forces



### SBD Configurations



Single Door



Double Door

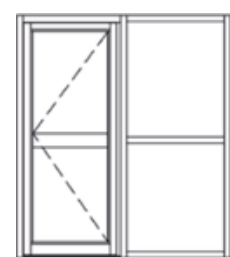

Single / Double Door with Side Screen



Single / Double Door with Fan Light



Screen

### 58BD HI COMMERCIAL DOOR SYSTEM

Performance and accreditations	Single	Double	GT55 TB Screening
U-Value (Double Glazing) (Ug: 1.1W/m²k)	1.7W/m²k	1.8W/m²k	1.4W/m²k
U-Value (Triple Glazing) (Ug: 0.7W/m²k)	1.5W/m²k	1.6 W/m²k	1.1 W/m²k
Air Permeability	-	-	Class 4 (600 Pa)
Water Tightness	-	-	Class E1200 (1200 Pa)
Wind Resistance	-	-	Class B4 (1600 Pa)
Security	PAS 24 & SBD when specified	PAS 24 & SBD when specified	PAS 24 & SBD when specified
<b>System</b>			
Depth	110mm	110mm	110mm
<b>Size and weight limits</b>			
Maximum Door Leaf Size (mm)	1200w x 2400h	2400w x 2400h	-
Maximum Door Weight	110kg	110kg	-
<b>Glazing</b>			
Glazing Thickness (Double Glazed)	24mm - 40mm	24mm - 40mm	26mm - 30mm
Thermally Broken	✓	✓	✓
Part M Compliant Low Threshold	✓	✓	✓
Part M Compliant Low Closer	✓	✓	-
Anti-finger Trap	✓	✓	✓
Sightline	145mm	176mm	55mm
Mid-Rail and Lay Bar	✓	✓	✓
Panel Door	✓	✓	-
Multi-Point Locking	✓	✓	-
Single-Point Locking	✓	✓	-
Concealed Hinges	✓	✓	-
Barrel Hinges	✗	✗	-
Electro Mechanical Locking Option	✓	✓	-





Choose from 39 Modern and Contemporary Designs

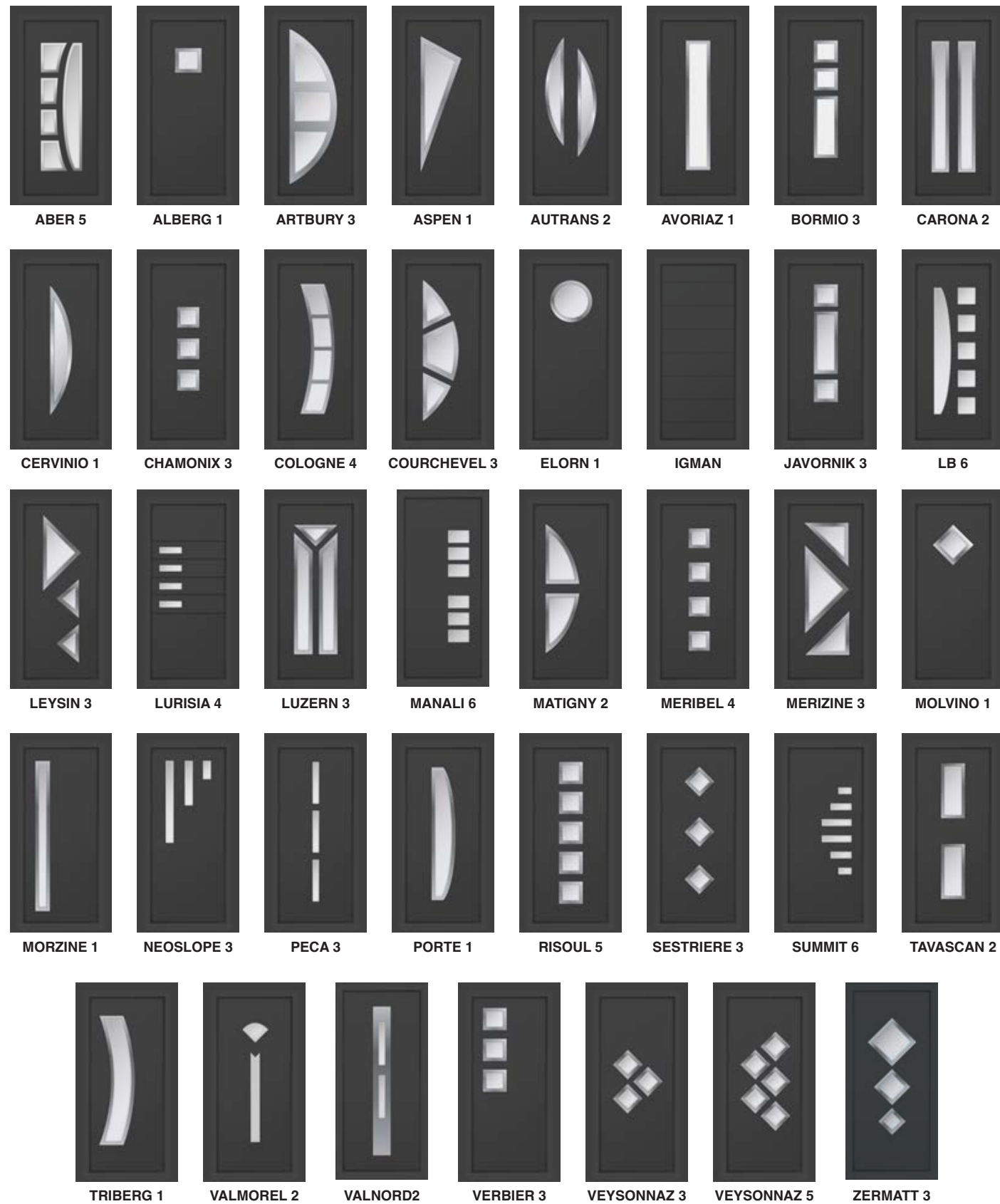

**Standard Colours**

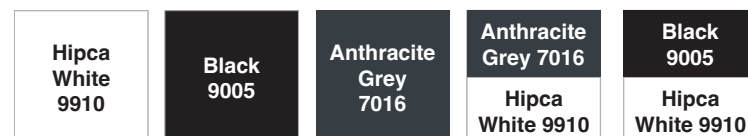

# Aluminium Designer Door Range

## Choices

Aluminium designer doors are a range of panelled doors for Residential and Commercial applications.

## Modern and Contemporary Designs



### STANDARD SPECIFICATIONS

- Range: 39 Designs
- Dimensions:  
Maximum O/A Single Door = 1050mm x 2200mm
- Paint: 60 - 80 microns
- Frame Depth: 58mm or 70mm
- Beading: Chamfered or Square
- Glazing: Clear, Plain Sandblast (Satin), Obscure (Pilkington Std Range)
- Handle Options: See page 47

### OPTIONS

- Solid MDF Core:**  
To allow fixing of Stainless Steel back to back only 'Straight Pull' or 'Offset' handles in the panel
- Low Threshold**
- Stainless Steel back to back 'In Line' or 'Offset' handles:**  
400/600/800/1000/1200/1400/1600mm



# Inotherm

Choose from over 200 ultra modern or traditional designs



AE 1046

AAE 1712

AGE 1030

AGE 1130

AGE 1527



AGE 1654

AK 402

ASS 1700

ATE 1451

AEE 1283

## A wide range in excess of 80 Colours and Finishes

From Standard to Matt, Metallic, Wood and Patterned

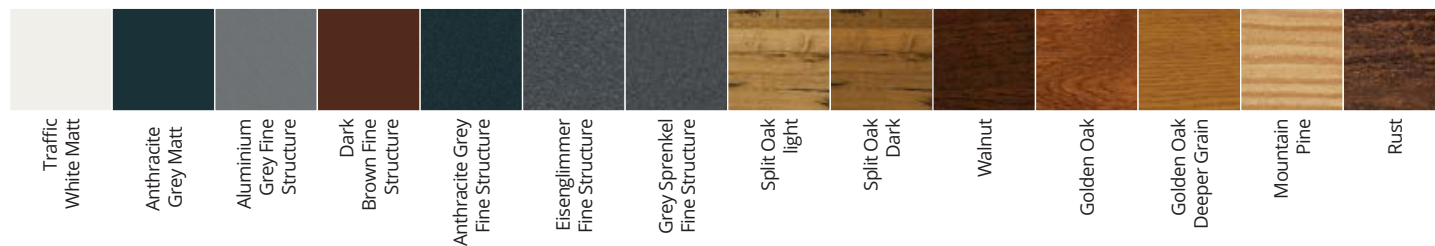

**Hinge Colours**  
Gold, Black and Silver

**Threshold Colours**  
Anodised Black, Silver and Anodised Gold



# Inotherm

## Choices

Inotherm aluminium doors are the crème de la crème of entrances and one of the most sought-after range of doors in Europe.

## EXCLUSIV Aluminium Entrance Doors

### 1 Above-standard profile thicknesses

Depending on the entrance door program you select, the thickness of the infill may be 54mm, 85mm and 105mm. Due to their above-standard thickness, all entrance doors provide you with outstanding thermal insulation and high energy savings.

### 2 Anti-bending expansion layer

For better statics, an expansion layer is added to all entrance doors, which prevents the bending or deformation of the entrance door and maintains the stability of the door even with large temperature swings.

### 3 Triple Glazing

All entrance doors feature glazing with three 6mm thick glass panes, which additionally insulate and enhance the safety of your home.

### 4 Additional seals

Our doors are sealed with three round liquid seals with vulcanised corner joints for better thermal insulation.

### 5 Thermal bridge interruption

A special heat barrier in the gap between the panel and the frame prevents heat from escaping and reduces your heating costs.

### 6 Aluminium threshold

A robust aluminium threshold with a thermal break reduces the energy flow in the lower part of the door and allows for the invisible mounting of the door frame.

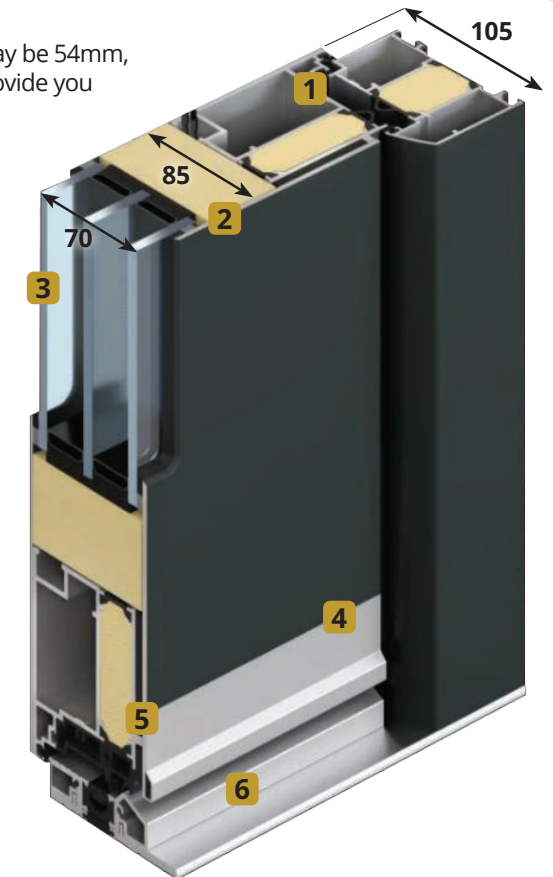

## Inotherm Features:

- ✓ "Design Your Own Door" feature available
- ✓ Single doors up to 1260mm wide x 2700mm high
- ✓ Schuco patented profile
- ✓ 0.7W/m<sup>2</sup>k - 0.9W/m<sup>2</sup>k 'U' value range
- ✓ 0.5W/m<sup>2</sup>k when in combination with motif and ornamental glass
- ✓ 3mm thick aluminium exterior and interior skins
- ✓ Triple glazed as standard
- ✓ 5/6 point locking as standard
- ✓ Modern and Traditional styles

## Optional Extras



Finger print recognition

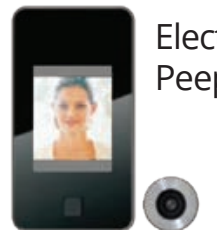

Electronic Peep-hole



InoSmart Security System

Retina recognition



Coming Soon





# SecureRoll Garage Doors

## Choices

Thermally efficient, made to measure remote controlled garage doors available in a wide range of colours that will perfectly complement 'Choices' Windows and Doors.

## SecureRoll

### Remote Controlled Garage Doors



#### SecureRoll Features:

- ✓ "Classic" design for typical garage door dimensions
  - 77mm Insulated slats
  - Secured by Design approval
- ✓ "Compact" design specifically for garages with limited headroom
  - 55mm Insulated slats
- ✓ Remote control operation
- ✓ A wide range of colours
- ✓ Comprehensive 5 year SecureRoll warranty
- ✓ Intruder alarm
- ✓ Courtesy light
- ✓ Holiday mode - Increased security
- ✓ Manual Override

A wide range in excess of 20 Colours - Standard to Wood laminate finishes

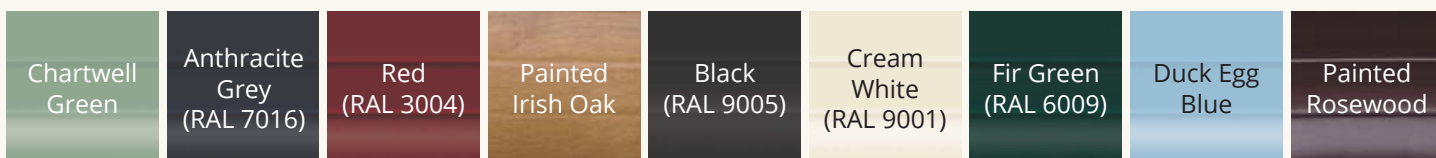

Safety Brake



Space Saving Roll



Manual Override



Anti-Lift Locking System



Durable Slats



Effective Weather Strip



Strong Guides and Slats



Wireless Safety Edge Sensor



Vision Panels Option



AluRoll are the company that holds the Secured by Design accreditation. CWG Choices Limited are an authorised reseller of Secured by Design products from AluRoll.





# 'Choices' Timber



# Timber Casement Windows

## Choices

High performance made to measure timber windows manufactured from the highest quality hardwood or engineered softwood.

## Crafted Timber Windows Storm Windows

'Choices' Crafted Timber Storm windows are a high performance casement window available as side hung or top hung with the option of glazing bars to create classic designs.

Hung on friction hinges with a choice of traditional furniture, 'Choices' Crafted Timber Storm windows come with internal decorative mouldings on both sash and frame to enhance appearance.



### Specification

- ✓ Engineered Redwood as standard
- ✓ Grandis hardwood upgrade option available
- ✓ All timber FSC® certified
- ✓ Default colour - Traffic White RAL 9016
- ✓ Standard 'Choices' stains - Mahogany, Cyprus Light Oak and Teak
- ✓ Choice of 22mm, 40mm or 56mm bonded Astragal bar
- ✓ PAS 24 enhanced security as standard
- ✓ Internally glazed
- ✓ 92mm front to rear outer frame
- ✓ Uw 1.4W/m2K with double glazing (Energy rating B)
- ✓ Uw 0.99W/m2K with triple glazing (Energy rating A)

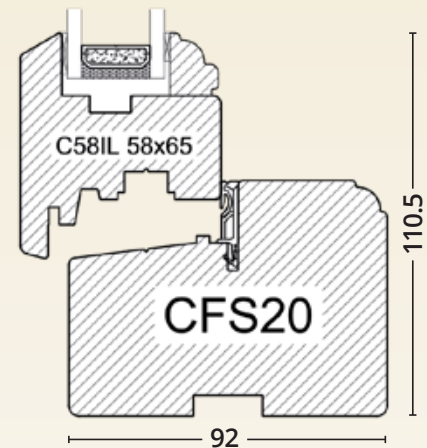

## Flush Windows

'Choices' range of Crafted Flush Casements is an advanced suite of outward opening flush casement windows.

With a choice of hinges they are available as outward opening casements or top swing fully reversible windows. This provides flexibility without compromising the external appearance of the building.



### Specification

- ✓ Engineered Redwood as standard
- ✓ Grandis hardwood upgrade option available
- ✓ All timber FSC® certified
- ✓ Default colour - Traffic White RAL 9016
- ✓ Standard 'Choices' stains - Mahogany, Cyprus Light Oak and Teak
- ✓ Choice of 22mm, 40mm or 56mm bonded Astragal bar
- ✓ PAS 24 enhanced security as standard
- ✓ Casements - Internally glazed
- ✓ Top swing fully reversible - Externally glazed
- ✓ 92mm front to rear outer frame
- ✓ Uw 1.4W/m2K with double glazing (Energy rating B)
- ✓ Uw 0.99W/m2K with triple glazing (Energy rating A)

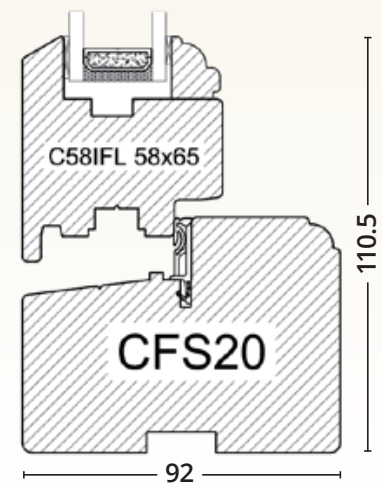

## Standard RAL Finishes

Dual finish options RAL / RAL or RAL

Traffic White 9016	Anthracite Grey 7016	Agate Grey 7038	Jet Black 9005	Mahogany Brown 8016	Cream 9001	Traffic Red 3020	Reseda Green 6011	Brilliant Blue 5007	Chartwell Green NCS3010-G 20 Y	Mahogany	Cyprus Light Oak	Teak
--------------------	----------------------	-----------------	----------------	---------------------	------------	------------------	-------------------	---------------------	--------------------------------	----------	------------------	------

## Standard Stain Finishes

Single stain both sides only

## GLAZING BEADS FITTING GUIDE

Download our Push-On Glazing Beads guide.

[www.cwgchoices.com/glazingbeads](http://www.cwgchoices.com/glazingbeads)





# 'Choices' Timber



## Vertical Sliding Sash Window

'Choices' Sliding sash windows are traditional looking box design vertical sliding windows with double hung sliding sashes.

The double glazed sashes slide by means of modern pre-tensioned springs on either side.



## Vertical Sliding Window Curved Top

'Choices' Sliding sash windows are traditional looking box design vertical sliding windows with double hung sliding sashes.

The double glazed sashes slide by means of modern pre-tensioned springs on either side.



## Cords and Weights

'Choices' Cords and Weights sliding sash double glazed windows still using traditional technology.

The sashes slide by means of cords, pulleys and weights. These windows are in demand for 'listed' buildings where traditional manufacture is specified.



# Timber Vertical Sliding Windows

## Choices

Employed extensively since the seventeenth century, sliding sash windows can still add charm to any building old or new.

## Crafted Vertical Sliding Sash Windows

### Standard Specification

- ✓ Engineered Redwood
- ✓ 160mm front to back
- ✓ 24mm double glazing
- ✓ Internally or Externally Beaded
- ✓ Default colour - Traffic White RAL 9016
- ✓ 'Choices' stains - Mahogany, Cyprus Light Oak and Teak
- ✓ Handles - Gold, Chrome and Graphite



The mark of responsible forestry



### Standard RAL Finishes

Dual finish options RAL / RAL or RAL / Stain

Traffic White 9016	Anthracite Grey 7016	Agate Grey 7038	Jet Black 9005	Mahogany Brown 8016
Cream 9001	Traffic Red 3020	Reseda Green 6011	Brilliant Blue 5007	Chartwell Green NCS3010-G 20 Y

### Standard Stain Finishes

Single stain both sides only

Mahogany	Cyprus Light Oak	Teak
----------	------------------	------

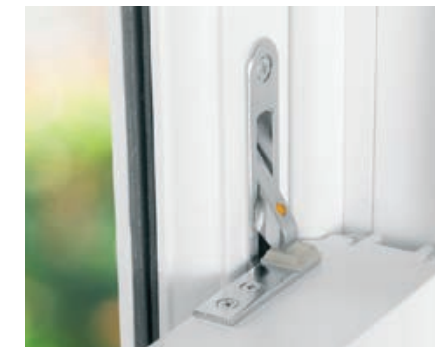

### Options

- ✓ Grandis hardwood option
- ✓ Optional bonded Astragal bars



# 'Choices' Scotdoor

Choose from 31 designs in a wide range of standard RAL and stain finishes



## Standard RAL Finishes

Dual finish options RAL / RAL or RAL / Stain

Traffic White 9016	Anthracite Grey 7016	Agate Grey 7038	Jet Black 9005	Mahogany Brown 8016
Cream 9001	Traffic Red 3020	Reseda Green 6011	Brilliant Blue 5007	Chartwell Green NCS3010-G 20 Y

## Minimum and Maximum door sizes

Widths = 850mm - 1080mm  
 Heights = 1900mm - 2250mm

Custom dimensions available on request.  
 Note heights are excluding optional sub sole



Arran 1 Stable Door

Side panels and top lights available

## Standard Stain Finishes

Single stain both sides only

Mahogany	Cyprus Light Oak	Teak
----------	------------------	------

## Architectural Letter Plate



Chrome, Gold, Antique Black, Graphite

## Door Handles (PAS 24 with 3 star cylinders)

### Standard



Balmoral



Chrome, Gold, Antique Black, Graphite

### Upgrades



Black or Pewter



Black or Pewter



Black or Pewter

## Security Chain



# Timber Scotdoor

## Choices

'Choices' Scotdoors combine tried and proven Scandinavian technology with traditional British styling to give exceptional performance against the weather and a high level of resistance to forced entry.

## High Performance Doors

### Specification

- ✓ Rebated door in engineered Redwood frame
- ✓ Full range of factory finished colours and stains
- ✓ Slab hung on 3 heavy duty adjustable security steel hinges
- ✓ Multi-point locking system
- ✓ Low level aluminium threshold as standard
- ✓ Integral draught strips and purpose designed weatherbars
- ✓ Door handle in Polished Chrome, Antique Black, White, Graphite, Satin, Gold, Black
- ✓ Clear or decorative obscure glass (not Oriel, Satinova or Warwick)
- ✓ PAS 24 as standard

'U' Values as low as **0.95**

AS STANDARD **PAS 24** 2022



## Construction

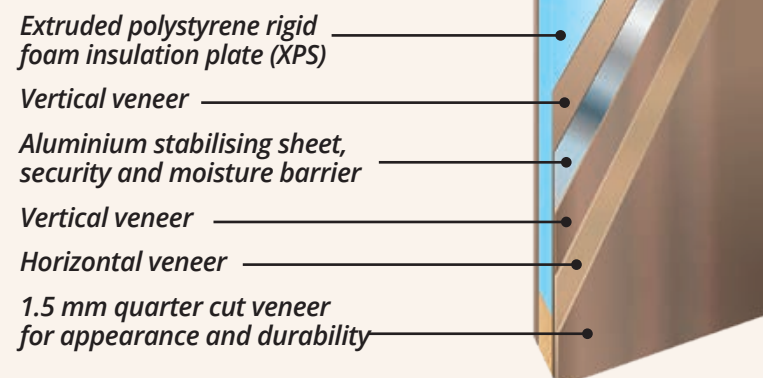

## Decorative Glass



View our Decorative Glass range on pages 74-75

## Threshold and Cill Details

### Aluminium threshold



### Optional 44mm sub sole

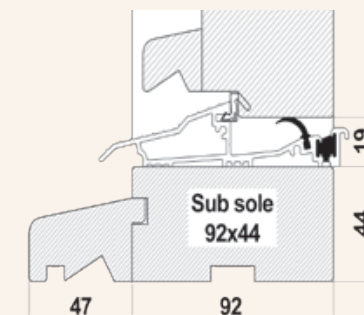

### Cill extensions

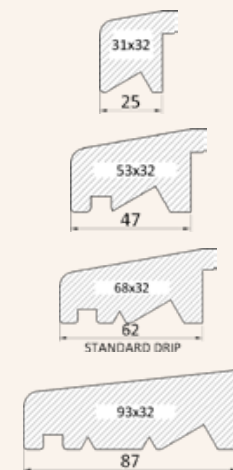

## Hinge Clearance

27mm



Slimline butt hinge offering 27mm plasterline clearance

Choices Timber Door range are supplied with aluminium threshold as standard offering a 19mm clearance. In addition a 44mm sub sole can be added to suit differing internal floor levels. Where suitable the sub sole can take a choice of 4 cill extensions.



# Scotdoor Decorative Glass Range



Dorchester  
Green, Amber, Blue

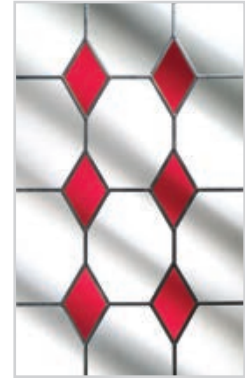

Diamonds  
Clear, Green, Red, Blue, Purple

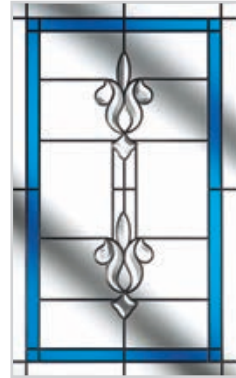

Designer Etch  
Purple, Blue, Green, Black



Murano  
Green, Black, Blue, Red, Purple

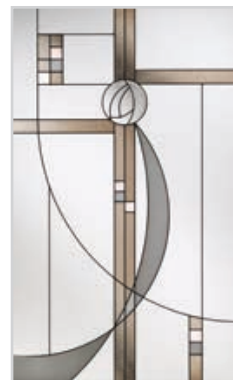

Caledonian Rose

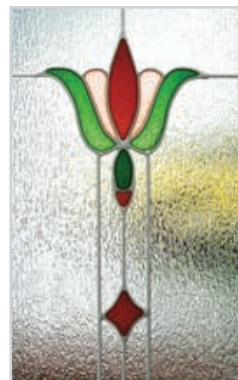

Fleur

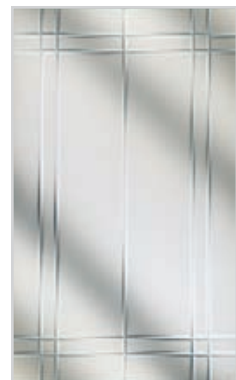

Linear



Kensington



Simplicity Zinc



Elegance



Prairie

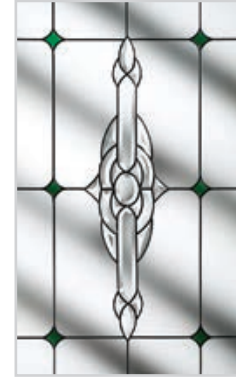

Crystal Bohemia



Dorchester



Elegance



Murano



Fleur



Caledonian Rose



Designer Etch



Simplicity Zinc



Bulls Eye

# Decorative Glass per Door

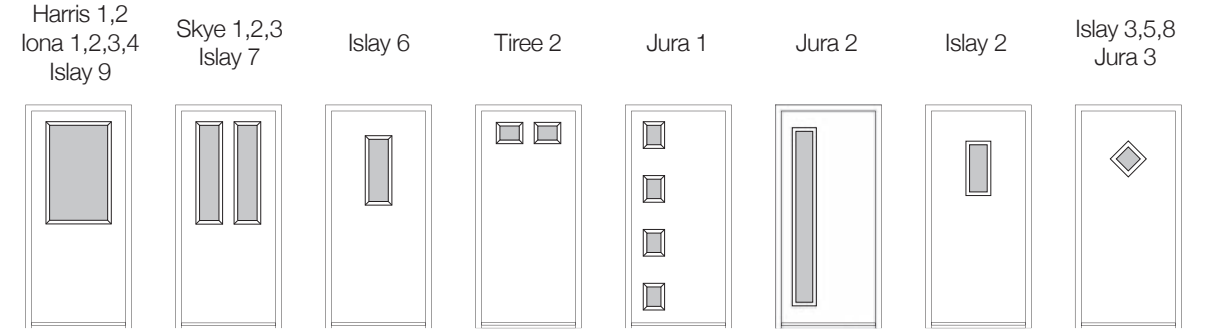

	Harris 1,2 Iona 1,2,3,4 Islay 9	Skye 1,2,3 Islay 7	Islay 6	Tiree 2	Jura 1	Jura 2	Islay 2	Islay 3,5,8 Jura 3
Dorchester 3 colours		✓	✓	✓			✓	
Diamonds 5 colours	✓	✓	✓	✓	✓	✓	✓	
Designer Etch 4 colours	✓	✓	✓	✓		✓		
Murano 5 colours	✓	✓	✓	✓	✓	✓		✓
Caledonian Rose	✓	✓	✓	✓			✓	
Fleur	✓	✓	✓	✓			✓	
Linear	✓	✓				✓		
Kensington	✓	✓	✓	✓	✓	✓	✓	✓
Simplicity Zinc	✓	✓	✓	✓	✓	✓	✓	✓
Elegance	✓	✓	✓	✓	✓	✓	✓	
Prairie	✓	✓	✓	✓	✓	✓	✓	
Crystal Bohemia	✓	✓				✓		
Satin	✓	✓	✓	✓	✓	✓	✓	✓
Bulls Eye								✓

## Door Styles - Clear or Obscure Glass Only

Harris 2, Iona 2, Iona 3, Mull, Arran 1 and Arran 2

## Solid Door Styles

Islay 1, Islay 4, Tiree 1, Jura 4 and Lewis



# 'Choices' Timber Doors

Choose from a range of designs in a wide range of standard RAL and stain finishes

Full Height Glass



Part Glazed Plain Panel



Part Glazed Grooved Panel



Part Glazed Raised and Fielded Security Panel



Full Height Glass



Part Glazed Plain Panel



Part Glazed Grooved Panel



Part Glazed Raised and Fielded Security Panel



## Standard RAL Finishes

Dual finish options RAL / RAL or RAL / Stain

Traffic White 9016	Anthracite Grey 7016	Agate Grey 7038	Jet Black 9005	Mahogany Brown 8016
Cream 9001	Traffic Red 3020	Reseda Green 6011	Brilliant Blue 5007	Chartwell Green NCS3010-G 20 Y

## Maximum door sizes

- Single Door Maximum Width = 1040mm
- Single Door Maximum Height = 2400mm
- Double Door Maximum Width = 2000mm
- Double Door Maximum Height = 2400mm



The mark of responsible forestry

## Standard Stain Finishes

Single stain both sides only

Mahogany	Cyprus Light Oak	Teak
----------	------------------	------

## Architectural Letter Plate



Chrome, Gold, Antique Black, Graphite

## Door Handles (PAS 24 with 3 star cylinders)

### Standard



Chrome, Gold, Antique Black, Graphite

### Upgrades



Black or Pewter



Black or Pewter



Black or Pewter

## Security Chain



## Choices

The 'Choices' range of high performance, made to measure timber doors are manufactured in the highest quality engineered softwood in a range of styles and sizes.

## Crafted Single and Double Doorsets

### Specification

- ✓ Engineered Redwood
- ✓ Grandis hardwood upgrade option available
- ✓ Low aluminium threshold
- ✓ Multi-point locking system
- ✓ Optional Astragal bar upgrade available
- ✓ Hardware to PAS24 / Doc Q as standard
- ✓ 6.8mm laminate required for PAS24 / Doc Q
- ✓ 28mm toughened 'Low E' glass
- ✓ Choice of 10 RAL colours and 3 stained finishes
- ✓ Door handle in Gold, Chrome, Antique Black, Graphite, Pewter
- ✓ Optional sub sole and cill extensions
- ✓ All timber FSC® certified



Timber single door with 15 pane Astragal design upgrade



Timber double doors with 20 pane Astragal design upgrade



## Threshold and Cill Details

### Aluminium threshold



### Optional 44mm sub sole

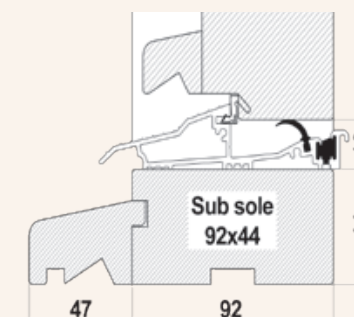

### Cill extensions

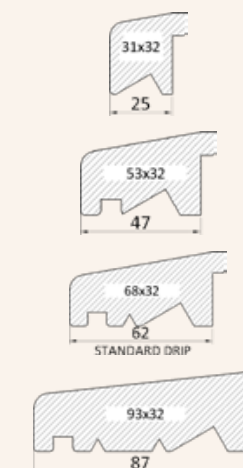

## Hinge Clearance

27mm



Slimline butt hinge offering 27mm plasterline clearance

Choices Timber Door range are supplied with aluminium threshold as standard offering a 19mm clearance. In addition a 44mm sub sole can be added to suit differing internal floor levels. Where suitable the sub sole can take a choice of 4 cill extensions.



# FD30S Fire Door Collection



These doors are suitable for internal usage such as flats or apartments where doors open onto a corridor or similar - not for opening to the weather.

Solid Core FD30S Door Style	Min Width (mm)	Max Width (mm)	Min Height (mm)	Max Height (mm)	Can Letterbox be fitted?
Wellow 2	733	1014	1931	2126	Yes
Wellow 3	733	1014	1931	2126	Yes
Wellow 4	670	1014	1984	2126	No
Normanton 1	733	1014	1931	2126	Yes
Normanton 2	670	1014	2119	2126	No
Rufford Solid	834	1014	1984	2126	Yes
Carburton Solid	733	1014	1931	2126	Yes
Maple Solid	834	1014	1984	2126	Yes
Abbey Solid	774	1014	1984	2126	Yes
Newstead Solid	874	1004	1984	2126	Yes

A representative selection of styles. For further styles please visit [www.cwgchoices.com/fd30s](http://www.cwgchoices.com/fd30s)

## GU Security Automatic - Fire Door Lock

This is a Slam Shut Lock. The spindle is situated at 960 from the bottom of the slab. Lock comes with fully adjustable composite keeps with edge protection.

With 3 deadbolts and centre latch this is a PAS23/24 tested lock. This is our only lock used on FD30S doors in conjunction with our fire testing certificate.



## ULTION FD30S Cylinder

### Thumbturn

ULTION 3 Security Cylinder with Secured By Design accreditation and Gold Secure Diamond Standard.



## Colour Options

Supplied with White Chamfered or Sculptured outer frame only

White RAL 9016	Duck Egg Blue	Sliver Grey RAL 7001	Anthracite Grey RAL 7016
Chartwell Green	Green RAL 6009	Red RAL 3011	Blue RAL 5011
Irish Oak	Golden Oak RAL 8001	Black Cherry	Black Brown RAL 8022
			Black RAL 9011

# Fire Door Collection

## Choices

FD30S - The Fire door with the solid core made from sixteen layers of Laminated Veneered Timber.

- ✓ FD30S Fire Doors
- ✓ Certified Registered CF705
- ✓ EN14449:2005-EN1279-5 Compliant Sealed Units
- ✓ Tested to BS476 Part 22 1987 Both Sides  
Report numbers 402105 & 403720
- ✓ BSEN 1154 Compliant Closers

## Glass Options

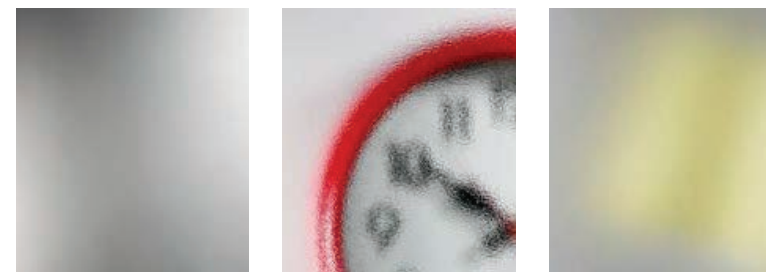

7mm Pyrodur with 6.8mm Clear

7mm Pyrodur with 6.8mm Stippolyte

7mm Pyrodur with 6.8mm Satin

## Standard Fit Fully controlled door closer

Astra Concealed Closer  
Easy speed adjustment makes this ultra efficient.



## Optional ASSA External fitted closer

Dorma Overhead Closer  
Rack and pinion closer with link arm.



## Union Powerload Butt Hinge

High Performance bushed bearing butt hinge.  
Radius corners for speed of fixing.



## Hardware

### Handles



Lever/Lever only

### Urn Knocker



Handles, Knockers and Letterplate available in: White, Black, Gold Effect, Chrome, Satin, Graphite

### Nu Mail Fire Letterplate



### Bull Ring Knocker



Gold Effect, Chrome, Graphite

### Spyhole



Gold Effect, Chrome only

### Security Chain



Chrome only

## Threshold Options

Gold Effect or Silver



**Stormguard AM3**  
Open In - No Cill - Part M Compliant



**Stormguard AM370**  
Open In - NOT Part M Compliant  
85, 150 or 180mm Special Reinforced Cills available



**Stormguard AM5**  
Open Out - Part M Compliant

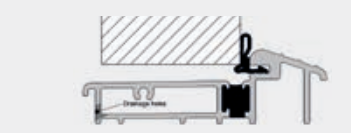

**Stormguard AM570**  
Open Out - NOT Part M Compliant  
85, 150 or 180mm Special Reinforced Cills available

One tube of "Specialised Sealant" supplied per door



# Alu Clad 'Choices' Timber



# Timber Aluminium Clad

## Flush Casement / Fully Reversible Windows



Outward opening flush casement windows with clean, straight edged timber frames and external aluminium cladding for a low maintenance solution. As an outward opening casement window, the functionality also allows for fully reversible for easy maintenance and cleaning.

The internal timber is, as standard, square edged (Softline) however it is also available with a slightly moulded, decorative finish (Classic).

### Specification

- ✓ Engineered (laminated) timber profiles
- ✓ Pine timber with external aluminium cladding
- ✓ Factory applied paint / clear on white tone lacquer
- ✓ Polyester Powder Coated (PPC) aluminium
- ✓ Casement and reversible hinges
- ✓ All multi-point locking
- ✓ Modern square profile - Softline
- ✓ Traditional moulded profile - Classic
- ✓ Factory fitted double or triple glazing
- ✓ Double glazed with overall U-value of approx 1.34W/m<sup>2</sup>K
- ✓ Triple glazed with overall U-value of approx 0.92W/m<sup>2</sup>K
- ✓ Externally beaded, drained and ventilated
- ✓ PAS24 option available



## Choices

Alu Clad timber windows and doors are manufactured from timber with an external aluminium cladding combining high levels of insulation and a low maintenance exterior finish

## 'Choices' Alu Clad Tilt and Turn

High performance inward opening, tilt & turn windows with an external aluminium cladding which provides a strong, durable external surface requiring minimal maintenance. This reduces future costs and improves the life expectancy of the product.

### Specification

- ✓ Timber only option available
- ✓ Engineered (laminated) timber profiles
- ✓ Pine or Oak
- ✓ Factory applied paint/clear lacquer/white tone lacquer options internally
- ✓ Tilt & turn, tilt only or turn only - all inward opening
- ✓ Circumferential fittings with tilt ventilation
- ✓ Factory fitted 24mm double glazing or 40mm triple glazing
- ✓ Internally beaded
- ✓ Overall U-value of (approx.) 1.2W/m<sup>2</sup>K - double glazed or 0.9W/m<sup>2</sup>K - triple glazed
- ✓ Shaped opening windows possible
- ✓ Durable external aluminium cladding
- ✓ PAS24 option available



## Alu Clad Doors

The 'Choices' Alu Clad door range is a high performance door system which includes:

- ✓ Entrance Doors
- ✓ French Doors
- ✓ Sliding Doors

With such a vast range of different solutions, each offering their own unique design features, we can offer a tailored solution perfect for your project.





# 'Choices' WARMroof

- ✓ Excellent thermal properties
- ✓ Cool in summer - warm in winter
- ✓ Added living space for all year use



## Tiled Effect Roof

Choices WARMroof systems are the most configurable and structurally robust, insulated and tiled roof in the UK market.

Whether you are looking to replace an existing conservatory roof only, refurbish an existing conservatory or build a brand new extension, our WARMroof technology underpins the design in each of our roofs to ensure we offer the very highest levels of thermal efficiency.



## Why consider a 'Choices' WARMroof?

- ✓ Award Winning! Voted Best Solid Roof System at the Conservatory & Orangery Awards
- ✓ Fully insulated tiled roof
- ✓ Fully guaranteed for 10 years with the tiles carrying either a 25 or 40 year warranty
- ✓ Choice of two tiles, yet it is structurally tested to take concrete, clay or slate tiles
- ✓ Fully compliant with Building Regulations throughout the UK and Scotland
- ✓ Thermal insulation of 0.15W/m<sup>2</sup>K
- ✓ Quick installation - less disruption to your home

One-piece top cap cover for decorative purposes which matches roof slate or tiles.

Tiles - either stock Envirotiles or TapcoSlate or slate, clay or concrete tiles.

Breathable, waterproof membrane between the top panels and tiles to assist with weatherproofing.

Retro-fit posts for extra support when using existing conservatory frames (when required)

Extra 50mm top panel insulation which insulates the bars and eliminates potential thermal bridging issues creating a true 'warm roof' structure.

100mm base panel insulation below the bars, retaining the heat within the room.

Fully insulated eaves, eliminating any risk of condensation.

## Choices

For those who have a requirement for more natural light there are rooflights and lanterns to consider

## Aluminium Lantern Roofs

The 'Choices' Korniche has classic timber lines and is constructed from the best in modern materials.

With the freedom to configure the strong, slender and carefully detailed rafters to create a bespoke design within the system parameters.

If you are going classic you can have symmetrical rafters with smaller glass spans and if you want to go modern, you can specify minimal rafters giving some of the biggest glazing spans available.

## Colour Options

Also available in a range of RAL or BS colours

Gloss White RAL 9010	Matt Anthracite Grey RAL 7016	Matt Black RAL 9005
-------------------------	----------------------------------	------------------------



# Rooflights & Lanterns



- ✓ Fast - quick and easy to install
- ✓ Strong - optimised to allow a minimal structure
- ✓ Warm - class leading thermal performance
- ✓ Slim - aesthetically stunning

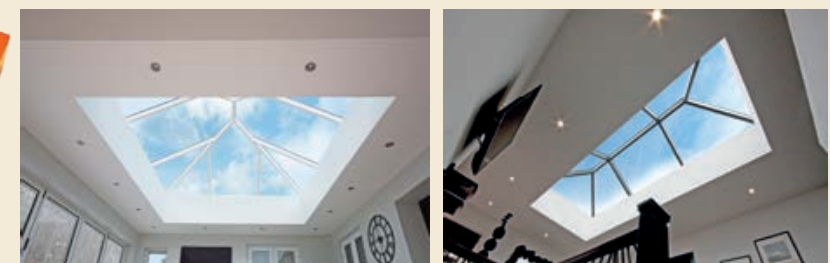

## 'Choices' Opal Rooflights

### High Performance Aluminium Rooflight

The Opal Rooflight is a high performance rooflight that is modern, slimline and easily maintained, making it perfect for any home. It is pre-assembled and with a one piece fixing method, it is the fastest and most secure rooflight to install.

### Features

- ✓ Ultra modern, slimline design
- ✓ Low profile design makes for easy maintenance
- ✓ One-piece fixing method for fast installation
- ✓ Modular and bespoke sizes available
- ✓ Suitable for residential properties
- ✓ Thermally broken aluminium frame
- ✓ Available in any RAL colour





# Choices 'Ultra4'

Modern glass technology allows glass to be used for so much more than something to look through. We have carried out tests on a wide range of our products, so we are able to advise whatever the requirement.

## 'Ultra4' The 'FOUR IN ONE' upgrade



### Thermal Performance

'Ultra4' offers 'A' rated thermal performance

A special microscopic coating on the glass helps reflect heat back into the room offering savings of up to 22% on energy bills versus single glazing. With windows giving up to 26% of heat loss, choosing the right glass and windows, is an important step to making your home warmer.

### Noise Control

'Ultra4' helps reduce external noise

Making our homes quieter by reducing unwanted noise from outside, is an undoubted benefit. 'Ultra4' reduces noise ingress by having a transparent sound absorbing layer, built into the glass. This makes it 20% better at reducing noise, than standard 'Choices' glass.



### High Security

'Ultra4' offers greater security

A very strong transparent film is glued between two layers of glass for the outside skin of the sealed unit, making it much harder to break than standard glass. In the case of an incident, the glass will not shatter, but be held by the film insert.

### Furniture Fade

'Ultra4' helps reduce colour fading

Fabrics on furniture, Curtains and Carpets fade when exposed to the sunlight. This is caused by the Ultra Violet rays from the sun. 'Ultra4' is designed to block 99.6% of these UV rays which cause such damage to your fabrics, thus allowing them to remain fresh looking and so longer lasting.

# Glazing Enhancements

## Choices

Offer a range of glazing enhancements to create modern and traditional looks with the addition of Georgian, Astragal or leadwork options.

### Astragal Bars



Available in a range of colours. Externally and internally fitted giving an authentic look and feel to any window, door or conservatory.



### Diamond Leadwork



Handcrafted in lead. Patterns available in diamond, rectangular Queen Anne and a variety of designs.

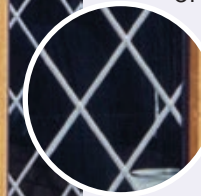

### Internal Georgian Bars



Internally fitted bars available in 18 or 25mm. Various styles include single bars, curved hoops and grid pattern.

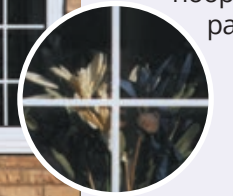

### Square Leadwork



Handcrafted in lead to create grid or border patterns.



### Obscure Glass



Different patterns to choose from with various levels of obscurity.





# Repair Kit Accessories

For topping up kits there are a range of accessories to choose from.



Hardwax



Aerosols

# König Repair Kits

## Choices

Easily repair scratches, minor gouges and scuff marks on foiled or non foiled PVCU windows and doors.

The blemishes created are minor in themselves, but major when the perfect job is expected.

König UK has the answer in that its repair kits are ideal when a PVCU window or door has been damaged in transit, when being installed or even when a customer has damaged the product.

## YouTube Demonstrations

### Complete Window Repair Kit and Demonstration



WATCH VIDEO

<https://cwgchoices.com/konig2>

### How to Repair Damage to an Extruded White UPVC Profile

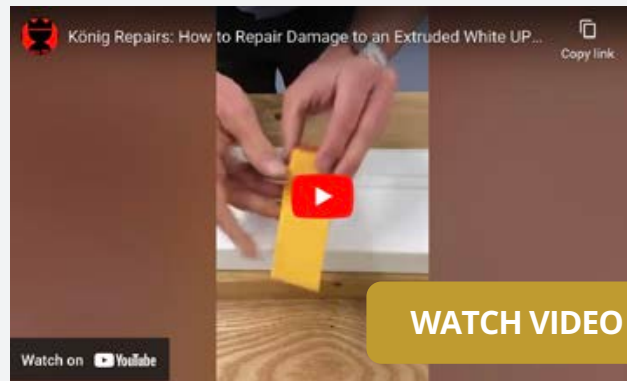

WATCH VIDEO

<https://cwgchoices.com/konig3>

### How to Repair Damage on UPVC Woodgrain Foil



WATCH VIDEO

<https://cwgchoices.com/konig4>

## PVCU Window and Door Repair Kits



### Window Doctor Repair Kit

The Window Doctor Kit is designed for installers and allows them to carry out simple "on-site" repairs to popular Renolit foils.

### The Complete Window Repair Kit

The Complete Window Repair Kit is designed for service engineers to carry out cosmetic repairs reducing the need for expensive and time consuming remakes.

The kit contains repair products for White Extrusion, Golden Oak, Irish Oak and Rosewood Renolit foils.



## Training Courses

### The kits are supported by a range of excellent hands-on repair courses

These training courses are designed to ensure you to get the most out of the König product range. Held at the König "in-house" training centre in Coventry or training can be arranged to be held on-site at your premises. [www.konig-uk.co.uk/training-courses](http://www.konig-uk.co.uk/training-courses)





CWG Choices Ltd.

## PRODUCT GUIDE 2025

### TRADE CUSTOMERS ONLY

#### PVCU Orders

Tel: 01536 271944

Email: pvcorders@cwgchoices.com

#### PVCU Quotes

Tel: 01536 271944

Email: pvcquotes@cwgchoices.com

#### Aftercare

Tel: 01536 271947

Email: pvcaftercare@cwgchoices.com

#### Aluminium

Tel: 01536 271948

Email: aluminium@cwgchoices.com

#### Timber

Tel: 01289 334631

Email: timber@cwgchoices.com

#### Transport

Tel: 01922 749277

Email: transport@cwgchoices.com

#### Tiled Effect Roofs & Lanterns

Tel: 01536 271944 Email: roofs@cwgchoices.com

### GENERAL ENQUIRIES

# Telephone: 01536 271940

### OUR LOCATIONS

#### CWG Corby

Pywell Road  
Corby  
Northants  
NN17 5XJ

#### CWG Aldridge

Shenstone Drive  
Aldridge  
West Midlands  
WS9 8TP

#### CWG Distribution

Tintagel Way  
Aldridge  
West Midlands  
WS9 8ER

### CHOICES ONLINE RESOURCES

**Marketing Support** - [www.cwgchoices.com/marketing](http://www.cwgchoices.com/marketing)

**Door Designers** - [www.cwgchoices.com/door-designers](http://www.cwgchoices.com/door-designers)

**Virtual Showrooms** - [www.cwgchoices.com/showrooms](http://www.cwgchoices.com/showrooms)

**Energy Calculator** - [www.cwgchoices.com/energy-calculator](http://www.cwgchoices.com/energy-calculator)



BS 6206  
BS 6262  
GEN 1279-2

*bmrada applicable to PVCU, Aluminium and Timber products made in CWG and Allan Brothers production facilities only.*